

Abstract

In this paper, according to the design requirements of a steel structural project, based on the principle of structural mechanics of thin-walled bar, the non-right angle H-section, which is subjected to bending moment and shear force, is taken as the object of study, the formulas of bending normal stress and shear stress are deduced. On this basis, the distribution of bending stress and shear stress and the location of dangerous stress are analyzed, the calculation method of section strength is discussed, and the FEA software ABAQUS is used to verify the above.

Keywords

non-right angle H-section, bending moment, shear force, stress calculation, strength analysis, FEA

1 Introduction

In the past two decades, the construction industry has developed by leaps and bounds, the building appearance become various. A building shown in Fig. 1 has an inclined facade. In the steel structure of the inclined facade, the steel beam uses a non-right angle H-section as shown in Fig. 2, ie, the angle between the web and the flange of the steel beam section is 80 degree to meet the appearance requirements of the building.



Fig. 1 An inclined facade of a building

In Fig. 2, the height of the non-right angle H-section is h , the width is b , the flange thickness is t_f , the web thickness is t_w , the angle between the web and flange is α . The cross section is geometrically non-symmetric. The shear centre and centroid own the same position. The origin of the coordinate system is located at the centre of the section, the X axis of coordinate system is parallel to the flange, the parameters of the cross section can be given as follows [1]:

moments of inertia:

$$\begin{aligned} I_x &= h^2 t_f b / 2 + t_w (h - t_f)^3 / (12 \sin \alpha) \\ I_y &= t_f (b^3 + 3bh^2 \cot^2 \alpha) / 6 \\ &\quad + \cot^2 \alpha t_w (h - t_f)^3 / (12 \sin \alpha) \end{aligned} \quad (1)$$

product of inertia:

$$I_{xy} = bh^2 t_f \cot \alpha / 2 + \cot \alpha t_w (h - t_f)^3 / (12 \sin \alpha) \quad (2)$$

¹ Mechanical Manufacturing and Automation,
 School of Mechatronic Engineering and Automation,
 Shanghai University,
 Yanchang Road 149, Shanghai, China

* Corresponding author, e-mail: pro666@qq.com

According to the size of the non-right angle H-section used in the project, and taking into account the common dimensions of the H-section [2] [3], the angle α is defined in the range of 70~90 degree, the range of height-to-width ratio $m (= h / b)$ is 1.0~3.0, and the range of thickness ratio of flange and web $k (= t_f / t_w)$ is 1.0~2.0.

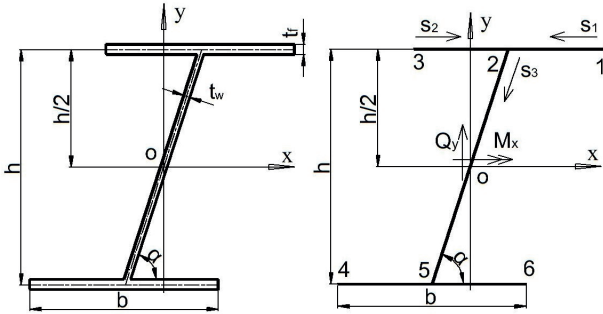

Fig. 2 Non-right angle H-section

In this paper, assuming that the beam member is simply supported, and subjected to a uniformly distributed load through the shear centre and parallel to the Y axis of the cross section. Therefore the internal force produced on the cross section is the shear force Q_y along the Y axis and the bending moment M_x around the X axis, see Fig. 2. The positive direction of the shear Q_y is along the positive direction of the Y axis, the positive direction of the bending moment M_x is determined by the right-hand screw rule.

2 Bending normal stress σ_z produced by bending moment M_x and its distribution

2.1 Calculation formula of bending normal stress

According to the thesis on thin-walled bar, the bending normal stress can be given by the formula [4]:

$$\sigma_z = -\bar{M}_y x / I_y + \bar{M}_x y / I_x \quad (3)$$

$$= M_x (-x I_{xy} / I_y + y) / (I_x \bar{I})$$

where \bar{M}_x and \bar{M}_y are effective bending moment:

$$\bar{M}_x = M_x / \bar{I}, \quad \bar{M}_y = M_x I_{xy} / (I_x \bar{I}), \quad \bar{I} = 1 - [I_{xy}^2 / (I_x I_y)].$$

x is the cartesian coordinate, see Fig. 2.

Formula (3) can also be written in the form of curvilinear coordinates:

$$\sigma_{s_1} = \frac{M_x}{2I_x \bar{I}} \left[2s_1 I_{xy} / I_y + h(1 - \cot \alpha \cdot I_{xy} / I_y) - b I_{xy} / I_y \right] \quad (4)$$

$$\sigma_{s_2} = \frac{M_x}{2I_x \bar{I}} \left[2s_2 I_{xy} / I_y + h(1 - \cot \alpha I_{xy} / I_y) + b I_{xy} / I_y \right] \quad (5)$$

$$\sigma_{s_3} = \frac{M_x}{2I_x \bar{I}} \left[h(1 - \cot \alpha I_{xy} / I_y) + 2s_3 (\sin \alpha - \cos \alpha I_{xy} / I_y) \right] \quad (6)$$

where, s is the curvilinear coordinate on the profile line, see Fig. 2. The positive direction of s is along the counterclockwise direction (around the cross-section centroid o), otherwise

negative. The starting point of s is at the opening of the cross section. The curvilinear coordinates and cartesian coordinates of each segment of the cross section are shown in Table 1. In the table, only the coordinates of the upper half of the cross section centroid are given: the flange segment from node 1 to node 2 is simply referred to as the flange segment 1. The flange segment from node 2 to node 3 referred to as the flange segment 2, and the web segment from the node 2 to the centroid referred to as the web. The coordinates of the lower half can be deduced according to the geometric anti-symmetry of the section.

When the calculation result of the formulas (3) to (6) is positive, the direction of the bending normal stress σ_z is the positive direction along the Z axis.

2.2 The distribution of bending normal stress

As for top flange, the coordinate is $x_{zero} = h I_y / (2 I_{xy})$ when the bending normal stress is zero ($\sigma_z = 0$). The coordinate of the node 1 (Fig. 2) is $x_{n1} = (b + h \cot \alpha) / 2$. The ratio of x_{zero} to x_{n1} is defined as:

$$\Delta_\sigma = x_{zero} / x_{n1} = h I_y / [(b + h \cot \alpha) I_{xy}]$$

where I_y and I_{xy} can be calculated using the formulas (1) and (2). Draw the $\Delta_\sigma - \alpha$ curve shown in Fig. 3. When drawing, take the ratio m as 1.0, 1.5, 2.0, 2.5 and 3 respectively, the ratio k as 1.0, 1.25, 1.5, 1.75 and 2.0 respectively. As can be seen from the Fig. 3, when α , m and k are within the range of this paper, $\Delta_\sigma > 0.5$.

The analysis of the formula (3) shows when $0.5 \leq \Delta_\sigma \leq 1.0$, the bending normal stress is zero at the top flange $x_{zero} = h I_y / (2 I_{xy})$, as shown in Fig. 4(a). When $\Delta_\sigma > 1.0$, the bending normal stress is always greater than zero, as shown in Fig. 4(b). As a special case, the bending normal stress is uniformly distributed on the top flange when the angle α is 90 degree, as shown in Fig. 4(c). The bending normal stress at the node1, node 2 and node 3 of the top flange can be calculated by formula (7) to (9).

$$\sigma_{n1} = M_x [h(1 - I_{xy} \cot \alpha / I_y) - b I_{xy} / I_y] / (2 I_x \bar{I}) \quad (7)$$

$$\sigma_{n2} = M_x h(1 - I_{xy} \cot \alpha / I_y) / (2 I_x \bar{I}) \quad (8)$$

$$\sigma_{n3} = M_x [h(1 - I_{xy} \cot \alpha / I_y) + b I_{xy} / I_y] / (2 I_x \bar{I}) \quad (9)$$

The analysis of the formula (3) also shows that the bending normal stress at the centroid of the web is zero, and the bending normal stress on the web is anti-symmetric linearly distributed with respect to the centroid, as shown in Fig. 4. The maximum and minimum stresses occur at node 2 and node 5 respectively, and the absolute value can be calculated by formula (8).

According to the geometric anti-symmetric feature of the cross section, the distribution of the bending normal stress on the flange and the web on the other half of the cross section can be drawn as shown in Fig. 4. The positive and negative signs in the figure indicate the positive and negative directions of the bending normal stress respectively.

Table 1 Curvilinear coordinate and Cartesian coordinate of the cross section component

Segment	Curvilinear coordinate	Starting node	Definition domain of s	Cartesian coordinate
Flange 1	s_1	Node 1	$[0, b/2]$	$x = s_1 + (b + h \cot \alpha)/2, y = h/2$
Flange 2	s_2	Node 3	$[-b/2, 0]$	$x = s_2 - (b + h \cot \alpha)/2, y = h/2$
Web	s_3	Node 2	$[-h/(2\sin \alpha), 0]$	$x = [h/(2\sin \alpha) + s_3] \cos \alpha, y = [h/(2\sin \alpha) + s_3] \sin \alpha$

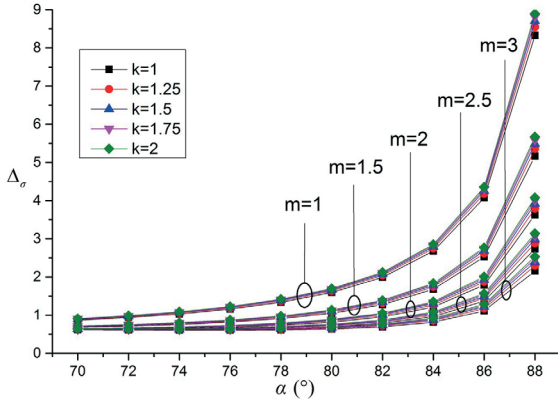
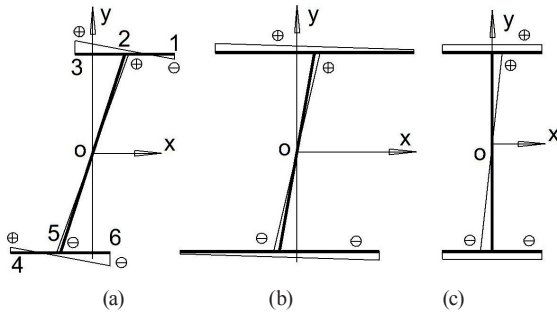
**Fig. 3** The curve of $\Delta_q - \alpha$ **Fig. 4** The distribution of bending stress on the cross section

3 The shear flow q produced by shear force Q_y and its distribution

3.1 Calculation formula of shear flow

In thin-walled bars, the shear flow q produced by the shear force Q_y on the cross section can be expressed by the following equation [4]:

$$\begin{aligned} q &= \tau \delta \\ &= -(\bar{Q}_y S_x / I_x + \bar{Q}_x S_y / I_y) \\ &= Q_y [S_y I_{xy} / I_y - S_x] / (I_x \bar{I}) \end{aligned} \quad (10)$$

where \bar{Q}_x , \bar{Q}_y are effective shear force, and $\bar{Q}_y = Q_y / \bar{I}$. S_x , S_y are the static moment of the cross section, and $S_x = \int_0^s \delta y ds$, $S_y = \int_0^s \delta x ds$. s is the curvilinear coordinate on the profile line. The symbol δ represents the wall thickness.

Solving equation (10), we can get the shear flow of each segment of the cross section.

$$\begin{aligned} q(s_1) &= \tau \delta(s_1) = -\frac{Q_y t_f}{2I_x \bar{I}} \{ I_{xy} s_1^2 / I_y \\ &\quad + [h - I_{xy} (b + h \cot \alpha) / I_y] s_1 \} \end{aligned} \quad (11)$$

$$\begin{aligned} q(s_2) &= \tau \delta(s_2) = -\frac{Q_y t_f}{2I_x \bar{I}} \{ I_{xy} s_2^2 / I_y \\ &\quad + [h + I_{xy} (b - h \cot \alpha) / I_y] s_2 \} \end{aligned} \quad (12)$$

$$\begin{aligned} q(s_3) &= \tau \delta(s_3) = -\frac{Q_y t_w}{2I_x \bar{I}} (1 - I_{xy} \cot \alpha / I_y) \\ &\quad \times [(\sin \alpha) s_3^2 + h s_3] + q(s_2)_{n2w} \end{aligned} \quad (13)$$

where $q(s_2)_{n2w}$ is the shear flow at node 2 on the web, which can be calculated using formula (12), but at this point, the definition domain of the curve coordinates should be $[-b, 0]$. Substituting $s_2 = -b$ into formula (12), we obtain the following formula:

$$q(s_2)_{n2w} = \tau \delta(s_2)_{n2w} = \frac{Q_y h t_f b}{2I_x \bar{I}} (1 - I_{xy} \cot \alpha / I_y) \quad (14)$$

When the value of the shear flow calculated according to formula (11) to (14) is positive, the direction of the shear flow is in the counterclockwise direction and vice versa.

3.2 The distribution of the shear flow

According to the above formulas, the shear flow on the flange and the web is in a parabola distribution.

For the shear flow on the flange segment 1, the coordinates of the parabolic symmetry axis is

$$s_{1sym} = [b + h(\cot \alpha - I_y / I_{xy})] / 2.$$

The coordinates of the midnode of the flange segment 1 is $s_{1cen} = b/4$. The ratio of s_{1sym} to s_{1cen} is defined as

$$\Delta_q = s_{1sym} / s_{1cen} = 2[1 + h(\cot \alpha - I_y / I_{xy})] / b.$$

Draw the curve shown in Fig. 5. When drawing, the values of the ratio m and the ratio k are the same as in Fig. 3. As can be seen from this figure, when m, k and α are within the ranges of this paper, $\Delta_q < 2.0$.

As shown in Fig. 6(a), when $\Delta_q < 2.0$, since the symmetry axis is on the right side of the node 1, the shear flow at the node 1 is zero and the shear flow at node 2 is the minimum in the flange segment 1.

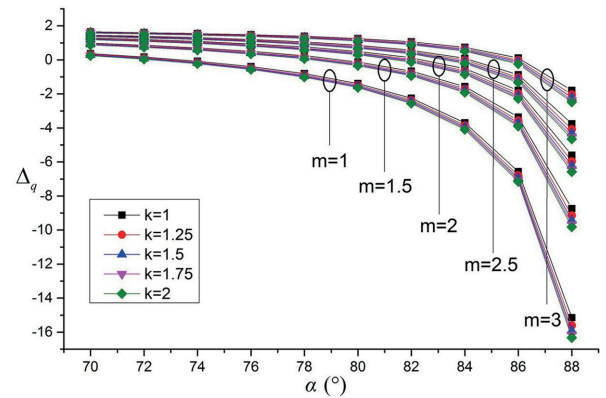
**Fig. 5** The curve of $\Delta_q - \alpha$

$$q(s_1)_{n2} = \tau\delta(s_1)_{n2} = \frac{Q_y t_f b}{4I_x \bar{I}} [-h + I_{xy} (b + 2h \cot \alpha) / (2I_y)] \quad (15)$$

As shown in Fig. 6(b), when $0 \leq \Delta_q < 1$, since the symmetry axis is between the node 1 and the midnode of flange segment 1, the shear flow is zero at node 1 and at the curvilinear coordinate $s_1 = [b + h(\cot \alpha - I_y/I_{xy})]$. The shear flow at the symmetry axis is the maximum of the flange segment 1.

$$q(s_1)_{sym} = \tau\delta(s_1)_{sym} = \frac{Q_y I_y t_f}{8I_x I_{xy} \bar{I}} [h - I_{xy} (b + h \cot \alpha) / I_y]^2 \quad (16)$$

The shear flow at node 2 is the minimum shear flow of the flange segment 1, which can still be calculated using formula (15).

As shown in Fig. 6(c), when $0 \leq \Delta_q < 2$, since the symmetry axis is between the node 1 and the node 2, the shear flow is zero at node 1 and the maximum and the second largest value of the flange segment 1 can be obtained at the symmetry axis and the node 2, respectively. These two values can still be calculated by formulas (16) and (15), respectively.

For the shear flow on the flange segment 2, the axis of symmetry of the parabola is:

$$s_{2sym} = -[b - h(\cot \alpha - I_y/I_{xy})] / 2 = -(1 - \Delta_q / 4)b$$

Since $\Delta_q < 2.0$, so $s_{2sym} < -0.5b$, that is, the axis of symmetry is always on the right side of node 2 (Fig. 6(c)). At this point, $q(s_2)$ is zero at node 3 and its maximum value on the flange segment 2 can be obtained at node 2.

$$q(s_2)_{n2} = \tau\delta(s_2)_{n2} = \frac{Q_y t_f b}{4I_x \bar{I}} [h + I_{xy} (b - 2h \cot \alpha) / (2I_y)] \quad (17)$$

For the shear flow on the web, the axis of symmetry is $s_{3sym} = -h/(2\sin \alpha)$, namely at the centroid. The shear flow $q(s_3)$ obtains its the maximum and minimum values at the symmetry axis and node 2, respectively. The minimum value at node 2 can be calculated by formula (14). The maximum value at the symmetry axis is:

$$q(s_3)_{sym} = \tau\delta(s_3)_{sym} = \frac{Q_y h^2 t_w}{8I_x \bar{I} \sin \alpha} (1 - I_{xy} \cot \alpha / I_y) + q(s_2)_{n2w} \quad (18)$$

As a special case, when $\alpha = 90^\circ$, the shear flow on the flange segment 1 and 2 is linearly distributed, and the shear flow on the web is still parabolic, as shown in Fig. 6(d).

According to the geometric anti-symmetric feature of the cross section, the shear flow distribution on the other half section is shown in Fig. 6. The direction of the arrow is the direction of shear flow.

4 Stress and Strength Analysis

4.1 Flange

Since $\Delta_q = 2[1 + h(\cot \alpha - I_y/I_{xy})/b] < 2$, so $I_y/I_{xy} - \cot \alpha > 0$. From the formula (7) and (9) we can see, $\sigma_{n3} - \sigma_{n1} = M_x b I_{xy} / (I_x I_y \bar{I}) > 0$, $\sigma_{n3} + \sigma_{n1} = M_x h I_{xy} [(I_y/I_{xy} - \cot \alpha)] / (I_x I_y \bar{I}) > 0$, therefore $|\sigma_{n3}| > |\sigma_{n1}|$. Because the bending normal stress on the flange is linearly distributed, the absolute value of the bending normal stress on flange segment 2 is greater than that of the normal stress on the flange segment 1.

Since $\Delta_q = 2[1 + h(\cot \alpha - I_y/I_{xy})/b] < 2$, so $I_y/I_{xy} - \cot \alpha > 0$. Take the curve coordinates $s_1 = s$, $s_2 = -s$, where $0 \leq s \leq b/2$. From formulas (11) and (12) we can see,

$$q(s_2) - q(s_1) = Q_y h t_f s (1 - I_{xy} \cot \alpha / I_y) / (I_x \bar{I}) \geq 0$$

$$q(s_2) + q(s_1) = Q_y t_f s (b - s) I_{xy} / (I_x I_y \bar{I}) \geq 0$$

Therefore $|q(s_2)| \geq |q(s_1)|$. Since s_1 and s_2 , in above equation, can take the arbitrary curve coordinate values on the flange segment 1 and the flange segment 2, the absolute value of shear stress on flange segment 2 is greater than or equal to the absolute value of shear stress on flange segment 1.

Let $A = 1/(2I_x \bar{I})$, $B = I_{xy}/I_y$, $C = h + I_{xy}(b - h \cot \alpha)/I_y$, then the bending normal stress and shear stress on the flange segment 2 can be simplified as $\sigma_z = M_x A(2Bs_2 + C)$, $\tau = -Q_y A(Bs_2^2 + Cs_2)$, respectively. According to von Mises criterion, or Maximum-Distortion-Energy Criterion, the von Mises stress on the flange segment 2 is $\sigma_m = \sqrt{\sigma_z^2 + 3\tau^2}$ [5], and its derivative is

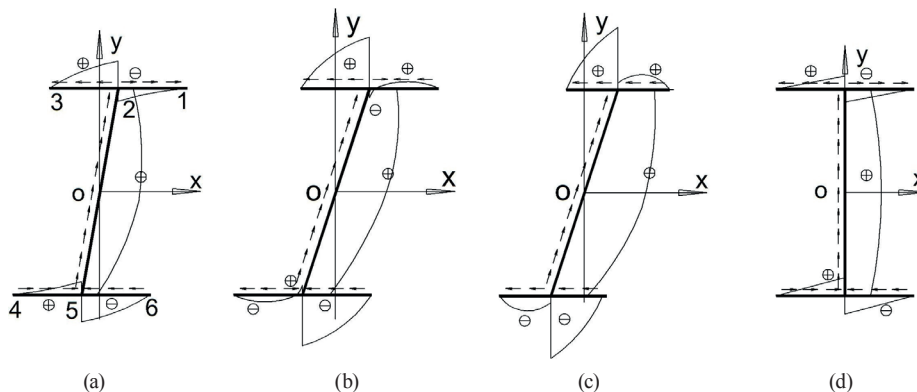

Fig. 6 The distribution of shear flow on the cross section

$$d\sigma_m/ds_2 = 3Q_y^2 B(2Bs_2 + C) \times [s_2^2 + Cs_2/B + 2M_x^2/(3Q_y^2)] \quad (19)$$

From the analysis given below, it can be seen that on the flange segment 2, since $d\sigma_m/ds_2$ has a tendency to increase monotonically, the von Mises stress σ_m is only possible to obtain the maximum value at the node 2 or the node 3. The detailed analysis is as follows:

$$(1) \text{ since } -C/(2B) = -\left[\frac{b + h(I_y/I_{xy} - \cot\alpha)}{2} \right] / 2 = s_{2sym} < -0.5b$$

and $-b/2 \leq s_2 \leq 0$, the part of formula (19). $2Bs_2 + C = 2B[s_2 + C/(2B)] > 0$. $s_2^2 + Cs_2/B + 2M_x^2/(3Q_y^2)$ is another part of formula (19), which is quadratic. The parabolic shape corresponding to this part is concave, and the coordinates of the parabolic axis of symmetry is $-C/(2B) = s_{2sym} < -0.5b$. Thus, on the flange segment 2, $d\sigma_m/ds_2$ has a tendency to increase monotonically.

(2) If the formula (19) has a zero point s_{2zero} in the flange segment 2, then $s_2^2 + Cs_2/B + 2M_x^2/(3Q_y^2) < 0$ in the interval $(-0.5b, s_{2zero})$, and $s_2^2 + Cs_2/B + 2M_x^2/(3Q_y^2) > 0$ in the interval $(s_{2zero}, 0)$. This means that on the flange segment 2, the maximum value of the von Mises stress σ_m (ie, the dangerous stress of the flange) must occur at node 2 or 3 [6].

It can be seen from the analysis of Section 2 and 3 of this paper that under the action of the bending moment M_x and the shear force Q_y , at the node 2 of the flange, there are both the bending normal stress σ_{n2} (see formula (8)) and the shear stress $\tau_{n2} = q(s_{n2})/t_f$ (where $q(s_{n2})_{n2}$ see formula (17)), then the von Mises stress at the nodes 2 can be expressed by $\sigma_{mn2} = \sqrt{\sigma_{n2}^2 + 3\tau_{n2}^2}$ on the basis of the von Mises criterion. There is only the bending normal stress σ_{n3} (see formula (9)) at the node 3 of the flange, so the von Mises stress at this node is $\sigma_{mn3} = \sigma_{n3}$.

For a right-angle H-section, since the bending normal stress on the flange is uniformly distributed, the critical stress on the flange only occurs at the node 2, and σ_{mn2} can be calculated by the above formula $\sigma_{mn2} = \sqrt{\sigma_{n2}^2 + 3\tau_{n2}^2}$.

4.2 Web

Similarly, under the action of the bending moment M_x and the shear force Q_y , there are both bending normal stress $\sigma_{n2w} = \sigma_{n2}$ (see formula (8)) and shear stress $\tau_{n2w} = q(s_{n2w})/t_w$ (where $q(s_{n2w})_{n2w}$ see formula (14)) at node 2 of the web, so the von Mises stress at this node is $\sigma_{mn2w} = \sqrt{\sigma_{n2w}^2 + 3\tau_{n2w}^2}$. At the midpoint of the web, there is only shear stress $\tau_{no} = q(s_{3sym})/t_w$ (see formula (18)), so the von Mises stress at this node is $\sigma_{mno} = \sqrt{3}\tau_{no}$.

4.3 Von Mises stress calculation formula

In summary, under the action of the bending moment M_x and the shear force Q_y , the von Mises stress calculation formulas on non-right angle H-section can be summarized as shown in Table 2.

5 Numerical calculation

The FEA software ABAQUS is used to validate the formulas deduced. Three non-right angle H-section beams are selected as the specimen, whose ends are simply supported and span $L = 3.0$ m. The uniform load is applied to the shear centre, $q = 10.0$ kN/m. The structure calculation diagram and FEA mesh is shown in Fig. 7.

5.1 Cross section size and stress distribution

The cross-sectional dimensions of the three specimens are: Sp1: $340 \times 250 \times 9 \times 14-80$, Sp2: $300 \times 200 \times 8 \times 12-75$, Sp3: $300 \times 150 \times 6.5 \times 9-70$. Here the dimension format is $h \times b \times t_w \times t_f - \alpha$. The values of $\Delta\alpha$ and Δq of the cross section of the specimens are shown in Table 3.

As can be seen from Table 3 and in Section 2.2 and 3.2 of this paper, for the specimen Sp1, since $\Delta\sigma > 0.1$ and $\Delta q < 0$, the distribution of the bending normal stress is expected to be similar to that of Fig. 4(b), and the shear stress distribution similar to that of Fig. 6(a). For Sp2, since $0.5 \leq \Delta\sigma \leq 1.0$ and $0 \leq \Delta q < 1$, the distribution of the bending normal stress similar to that of Fig. 4(a), and the shear stress distribution similar to that of Fig. 6(b). For Sp3, since $0.5 \leq \Delta\sigma \leq 1.0$ and $1 \leq \Delta q \leq 2$, the distribution of the bending normal stress similar to that of Fig. 4(a), and the shear stress distribution similar to that of Fig. 6(c).

5.2 Numerical results

In the FE calculation, the 4-node reduced integration shell element S4R in the ABAQUS is used [7], and the mesh size is 5mm. In order to apply the simple boundary condition at the beam ends, the reference point RP is set at the shear centre of cross section at both ends of the beam (see Fig. 7), and then all the DOF of all nodes in the cross section are coupled with RP using distributed coupling mode [8], finally apply simple boundary condition at RP [9][10].

Table 2 Von Mises stress calculation formulas

Stress	Flange		Web	
	Node 2	Node 3	Node 2	Node O
von Mises stress σ_m	$\sigma_m = (\sigma_z^2 + 3 \cdot \tau^2)^{0.5}$			
Normal stress σ_z	Formula (8)	Formula (9)	Formula (8)	Zero
Shear stress τ	Formula (17)	Formula (14)	Formula (14)	Formula (18)

Table 3 The values of $\Delta\alpha$ and Δq of the specimens

parameter	Sp1	Sp2	Sp3
$\Delta\alpha$	1.19	0.80	0.64
Δq	-0.46	0.56	1.26

According to the distribution of the bending moment M_x and the shear force Q_y , see Fig. 7, in order to avoid the bending normal stress σ_z , or the shear stress τ is zero, the stress

calculated by FEA software are extracted from the cross section at a distance of $L/4$ ($= 0.750$ m) from the support point. Correspondingly, when calculated in accordance with the formulas, the shear force on the cross section is $Q = qL/4$ and the bending moment $M = 3qL^2/32$ [11]. The elastic modulus of the steel is $E = 2.1 \times 10^5$ N/mm² and the Poisson's ratio $\mu = 0.3$.

Fig. 8 to Fig. 10 show the distribution of the bending normal stress σ_z and the shear stress τ of the flange and web, which are based on the results of the formula (labeled with Formula in the figures) and the those of FEA software (labeled with FEA). The abscissa in the figures use the Curvilinear coordinates. Fig. 11 and Fig. 12 show the distributions of the Mises stress for the flange and web of the three specimens. Table 4 gives the stress at the dangerous points (see Section 4 and Table 2) on the cross section of the specimens, which are calculated using the formulas in Table 2 and the FEA software.

As can be seen, the stress obtained by the formula is close to that obtained by FEA software, but not equal. The average values of the stress differences at the nodes on each segment of the cross section obtained by the above two methods are shown in Table 5. The average value of the stress difference

$$Avg. = \frac{1}{n} \cdot \sum_{i=1}^n |Formula - FEA|,$$

where *Formula* is the stress obtained by the formulas, FEA is by FEA software, and *n* is the number of nodes in the segment.

On the one hand, in deriving the formula of this paper, the following assumptions used in the structural mechanics of the thin-walled bar result in a slight deviation in the calculated results: (1) The plane assumes, that is after the deformation, the cross section is still flat and perpendicular to the axis of the member. (2) Since the wall thickness is very small, it is assumed that the bending shear stress is evenly distributed along the wall thickness and acts along the tangential of the contour line [4]. On the other hand, in the above figures and tables, the stress obtained by FEA software is extracted from the mesh nodes. The stress on a node is derived from the extrapolation and averaging of the integral points of the elements connected to it [12], so the node stress is not exactly

the exact value in the strict sense. The above two aspects may be the main reason why the stresses obtained by the above two methods are very close to each other, but not equal.

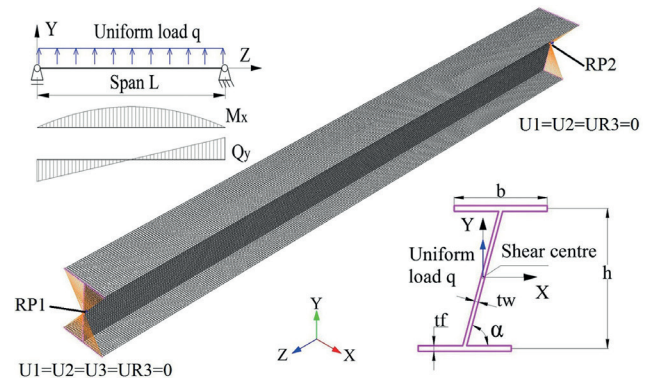

Fig. 7 The structure calculation diagram and FEA mesh

6 Summary

Due to the anti-symmetric geometrical characteristics of the non-right angle H-section, under the action of the bending moment and the shear force the distribution of the bending normal stress and the shear stress on the flange of the non-right angle H-section is different from that of the right angle H-section, see Fig. 4 and Fig. 6. Although the distribution of bending stress and shear stress on the web is the same as that of the right angle H-section, the magnitude of the stress is different, see Table 2. Therefore, when calculating the stress and checking the strength of non-right angle H-section beams, special attention should be paid to above characteristics.

Table 4 The stress at the dangerous points, MPa

Specimen	Calculation method	Flange		Web	
		Node 2	Node 3	Node 2	Node o
Sp1	Formula	6.498	11.373	7.281	4.519
	FEA	6.394	11.085	7.171	4.536
Sp2	Formula	10.507	24.297	11.166	5.811
	FEA	10.239	23.625	10.906	5.825
Sp3	Formula	17.494	62.382	17.698	7.341
	FEA	16.916	60.205	17.189	7.356

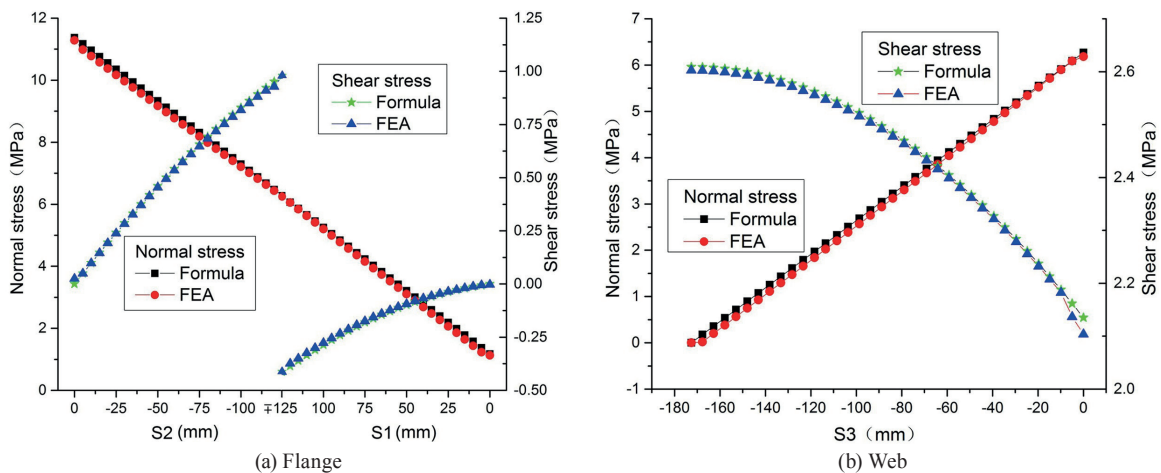
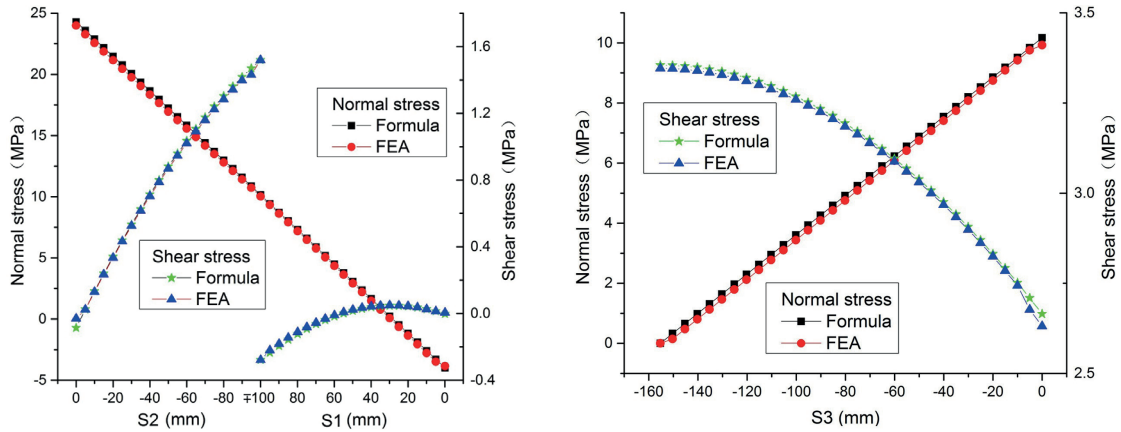

Fig. 8 Stress distribution of Sp1

Table 5 The average value of the stress difference

Specimen	Stress	Section segment		
		Flange 1	Flange 2	Web
Sp1	Normal stress σ_z	0.086	0.136	0.096
	Shear stress τ	0.031	0.035	0.007
Sp2	Normal stress σ_z	0.146	0.267	0.150
	Shear stress τ	0.048	0.058	0.010
Sp3	Normal stress σ_z	0.251	0.606	0.255
	Shear stress τ	0.074	0.101	0.013



(a) Flange (b) Web

Fig. 9 Stress distribution of Sp2

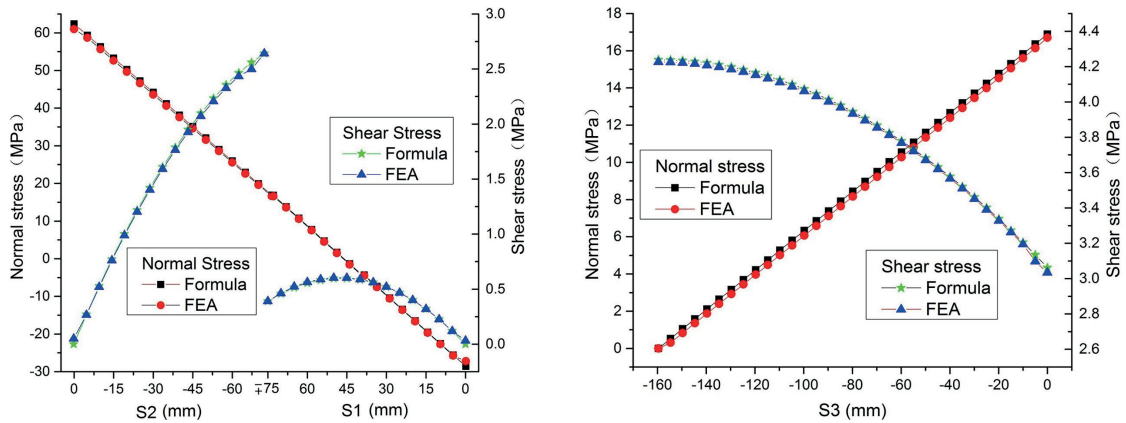

(a) Flange (b) Web

Fig. 10 Stress distribution of Sp3

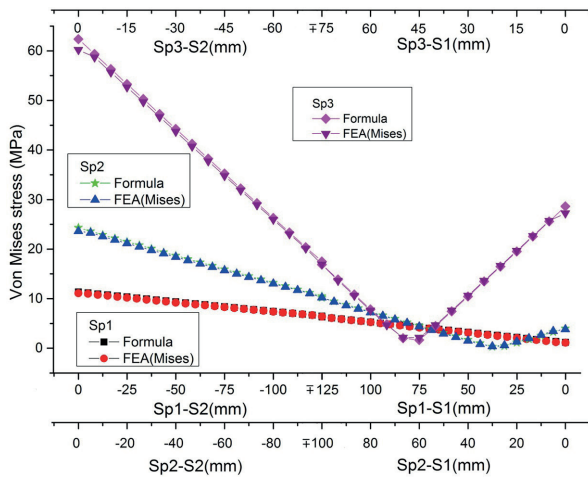

Fig. 11 Von Mises stress on the flange

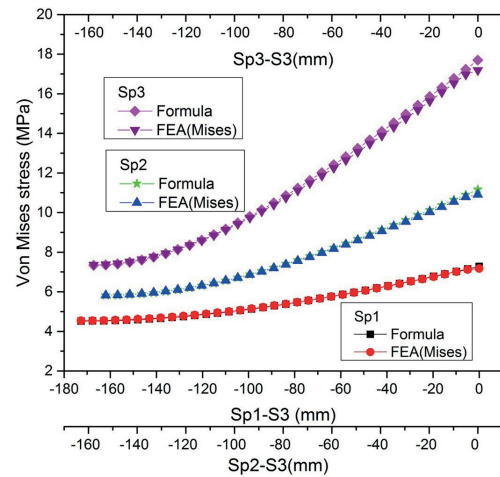

Fig. 12 Von Mises stress on the web

References

- [1] Beer, F. P., Johnston Jr. R. E., Dewolf, J. T., Mazurek, D. F. "Moments of Areas". In: *Mechanics of Materials*. pp. A2-A11, The McGraw-Hill Companies, New York, 2012.
- [2] GB/T11263-210. Hot-rolled H and Cut T Section Steel. National Standard of The People's Republic of China. 2010. (in Chinese). <https://www.chinesestandard.net/PDF-Excerpt/ShowPDFexcerpt.aspx?ExcerptID=GB/T%2011263-2010>
- [3] Xing Rong, L., Cai Ang, W. "Steel Design Manual connection node". pp. 373-381. China Building Industry Press, 2014. (in Chinese).
- [4] Shihua, B., Jian, Z. "Bending and free torsion of thin-walled bars". In: *Thin-walled structural mechanics*. pp.2-6. China Building Industry Press, 2006. (in Chinese).
- [5] Beer, F. P., Johnston Jr. R. E., Dewolf, J. T., Mazurek, D. F. "Transformations of Stress and Strain Moments of Areas". In: *Mechanics of Materials*. pp. 437-511. The McGraw-Hill Companies, New York, 2012.
- [6] Zorich, V. A. "Differential Calculus". In: *Mathematical Analysis I*, pp. 173-324. Springer-Verlag, 2004.
- [7] Abaqus Inc. "29.6.7 Three-dimensional conventional shell element library". *Abaqus Analysis User's Guide*. 2012. <http://abaqus.software.polimi.it/v6.14/books/usb/default.htm>
- [8] Abaqus Inc. "35.3.2 Coupling constraints". *Abaqus Analysis User's Guide*. 2012. <http://abaqus.software.polimi.it/v6.14/books/usb/default.htm>
- [9] Badari, B., Papp, F. "On Design Method of Lateral-torsional Buckling of Beams: State of the Art and a New Proposal for a General Type Design Method". *Periodica Polytechnica Civil Engineering*, 59(2), pp. 179-192. 2015. 10.3311/PPci.7837
- [10] Szalai, J., Papp, F. "A new residual stress distribution for hot-rolled I-shaped sections". *Journal of Constructional Steel Research*, 61(6), pp. 845-861. 2005. 10.1016/j.jcsr.2004.12.004
- [11] Beer, F. P., Johnston Jr. R. E., Dewolf, J. T., Mazurek, D. F. "Analysis and Design of Beams for Bending". In: *Mechanics of Materials*. pp. 331, The McGraw-Hill Companies, New York, 2012.
- [12] Abaqus Inc. "42.6.6. Controlling result averaging". *Abaqus/CAE User's Guide*. 2012. <http://abaqus.software.polimi.it/v6.14/books/usi/default.htm>