

Comparison of Linear and Nonlinear Behavior of Track Elements in Contact-Impact Models

62(4), pp. 963–970, 2018

<https://doi.org/10.3311/PPci.12058>

Creative Commons Attribution

Jabbar Ali Zakeri¹, Mosab Reza Tajalli^{1*}

RESEARCH ARTICLE

Received 07 February 2018; Revised 19 April 2018; Accepted 09 May 2018

Abstract

Existence of short wave length irregularities and discontinuities in the rail, such as corrugation, isolated rail joints, crossings and rail breakage, result in impact forces and an increase in wheel-rail contact force. Extreme forces in such could result in non-linear behavior of ballast and pads, and as a result, employing common linear models might over/under estimate contact forces. A 3D model of wheel and rail is developed in this paper, and by considering rail breakage, validity of linear models and considering non-linear behavior of materials are studied. Wheel-rail interactions are studied for two common pads with high stiffness (HDPE) and low stiffness (Studded) for speeds of 20 to 160 km/h. Three behavioral patterns are considered for the developed 3D model: linear pad and ballast (LP-LB), nonlinear pad and linear ballast (NLP, LB), and non-linear pad and ballast (NLP, NLB), and results are compared. According to the results, for HDPE pads and impact forces of up to 30 tons, linear model for material could estimate acceptable results. Yet for studded pads, linear model estimates forces that are comparably less than those estimated by non-linear model. Moreover employing NLP-LB model overestimates pad and wheel-rail contact forces by a rather small margin, compared to those estimated by NLP-NLB model, and hence, could be a suitable replacement for it. It is also observed that in order to have a reliable estimate of ballast forces, using non-linear ballast models are mandatory, and neither LP-LB nor NLP-LB could be acceptable replacements.

Keywords

wheel-rail interaction, contact-impact model, nonlinear analysis, contact force

1 Introduction

Due to an increasing trend in higher axle loads and operational speeds, employing numerical models for estimation of dynamic response of track and a reliable estimate of forces in superstructure elements are of great importance [1-3]. Deciding on a suitable behavioral model for track elements is one of the most important issues in numerical models. The common approach in train-track interaction studies is to consider linear behavior for track elements [4, 5].

In cases where the wheel-rail contact forces are almost equal to static wheel loads and its variations are limited, it makes sense to use a linear behavioral model. Nevertheless, in cases with short wave-length irregularities or rail discontinuities, wheel-rail forces are significantly increased and application of a non-linear model is inevitable. Due to high computational effort of such models, linear behavioral models are employed by researchers in most cases [6–9]. One such study was carried out by Kar Wu and Thompson [10], in which the effect of wheel crossing over an isolated rail joint is studied to determine contact forces and resultant noises. Track and rail models are modeled linearly, and non-linear Hertz model is used for wheel-rail interaction. Isolated rail joint is introduced in interaction equations as an irregularity function. Considering the joint gap, vertical alignment of joint, and vertical profile of rail, impact forces are shown to be 4 to 6 times higher than static wheel forces.

Dokipati and Dong [11] also used an interaction model of rigid body dynamic to study the impact forces on isolated rail joints. The track is modeled as a beam resting on discrete foundations, and linear behavior is considered for track elements. Based on results, it is concluded that increasing the vertical position of rails in the isolated rail joint zone could decrease the impact forces. Suarez et.al [12, 13] have also assessed the safety of an underground rail vehicle, crossing over a high resilient track in the presence of rail breakage. Two fastener systems with different stiffness are considered in this study. A multi-body system is employed to study the dynamic interaction of train-track, and finite element method is used to model the track. Superstructure elements are modeled with

¹ School of Railway Engineering,
Iran University of Science and Technology

* Corresponding author, email: m_tajalli@rail.iust.ac.ir

linear stiffness and damping characteristics. It is concluded that decreasing the speed would reduce the safety parameter of the track for both fastening systems.

Some researchers have also studied the effects of considering non-linear behavior for track elements [14–16]. Wu and Thomson [14] have studied the effects of non-linear track modeling on impact forces. Rail is modeled using a Timoshenko beam element, rail pad and ballast are also modeled as non-linear springs correlated with force, which were not capable of withstanding tensile forces. Wheel-rail interaction is modeled using Hertz contact spring, and wheel's impact forces are introduced in interaction functions as relative deflections. It is concluded that both impact forces and vibration levels are significantly higher than those estimated by a linear model.

Uzzal et.al [17] have also carried out modeling, calibration and assessment of a 3D model of a train-track system in the presence of wheel defects. Multi-body system model is employed for wagon, and track is modeled as a Timoshenko beam resting on discrete foundations. Non-linear springs and dampers are employed to model rail pads and ballast material. It is shown that employing non-linear models for rail-pads and ballast material could result in more accurate results compared to those of a linear model.

The aim of this paper is to study the effects of considering non-linear behavior of track elements on track and wheel-rail impact forces. Since the existence of rail breakage could significantly increase impact forces, a 3D interaction wheel-rail model with rail breakage is employed. According to previous studies, increasing the operational speed and axle load could lead to a higher frequency of rail and weld breakages [18, 19]. Such breakages are the main cause of derailments [20]. In this regard, having a realistic estimation of wheel-rail contact forces could have a significant effect in reducing the risk of derailments.

To assess the effects of non-linear modeling, two types of rail pads with various stiffness and damping characteristics are used in the interaction model. Moreover, effects of non-linear ballast modeling on forces on track elements and wheel-rail forces are determined. Verification of results is carried out by comparing the results of the model to those presented in references.

2 Modeling

A 3D model of the rail with a length of 13.6m is modeled on discrete foundations including pads, ballast and substructure. The distance between discrete foundations is equal to the distance between the sleepers, equaling 60cm. rail seat width is equal to that of the rail on sleeper, which is 16cm.

Considering the high frequency of impacts due to rail irregularities, rail is considered to be the most important of all superstructure elements. Since one of the primary goals of this paper is accurate determination of impact values, rail is modeled by solid

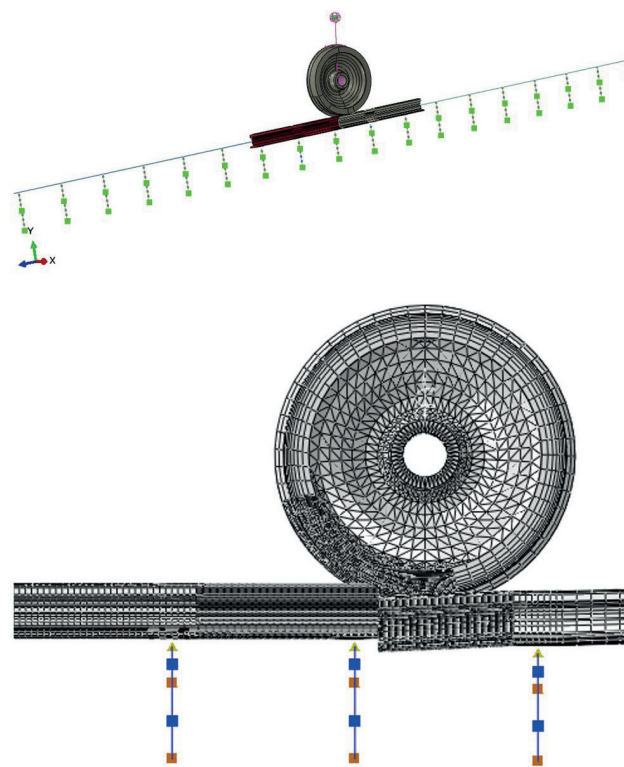

Fig. 1 Modeling rail on discrete foundations

Table 1 Material characteristics of steel.

| | |
|-----------------------|------------------------|
| Modulus of elasticity | 210 GPa |
| Poisson's ratio | 0.3 |
| Density | 7850 kg/m ³ |
| Yield stress | 780 MPa |

elements in the contact surface between wheel and rail. Yet to reduce computational effort, beam elements are used for modeling rail in sections in which rail-wheel contact is not of interest.

To reduce computational efforts, other elements of track are modeled as a combination of masses and springs. In this regard, pads and fasteners are modeled as a layer of springs and dampers, sleepers are modeled as a concentrated mass over the springs and dampers of ballast layer. Ballast layer is also modeled as a concentrated mass on springs and dampers of substructure (Fig. 1). Material characteristic of wheel and rail steel are as presented in Table 1.

Since stresses are extremely high in the contact region, steel materials are modeled with elasto-plastic characteristics in contact surface. But the steel in other regions is modeled with elastic characteristics.

In order to study the effects of non-linear pads, two pad characteristics are adopted from the study by Kaewunruen and Remennikov [21]. One is a high density poly-ethylene pad (HDPE) and the other a studded pad. According to the product brochure, HDPE pads have a dynamic stiffness range of 700-900 MN/m, and that of studded pads is 45–65 MN/m. A sample of each pad is presented in Fig. 2. Stiffness and damping characteristics of two pads are determined using material tests, which are presented in Fig. 3.

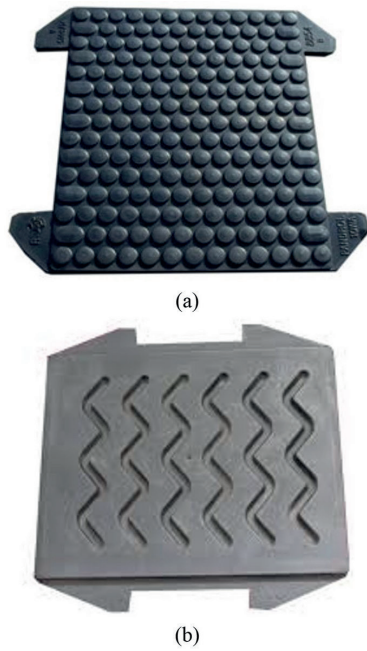

Fig. 2 A sample photo of modeled pads: a) studded, b) HDPE.

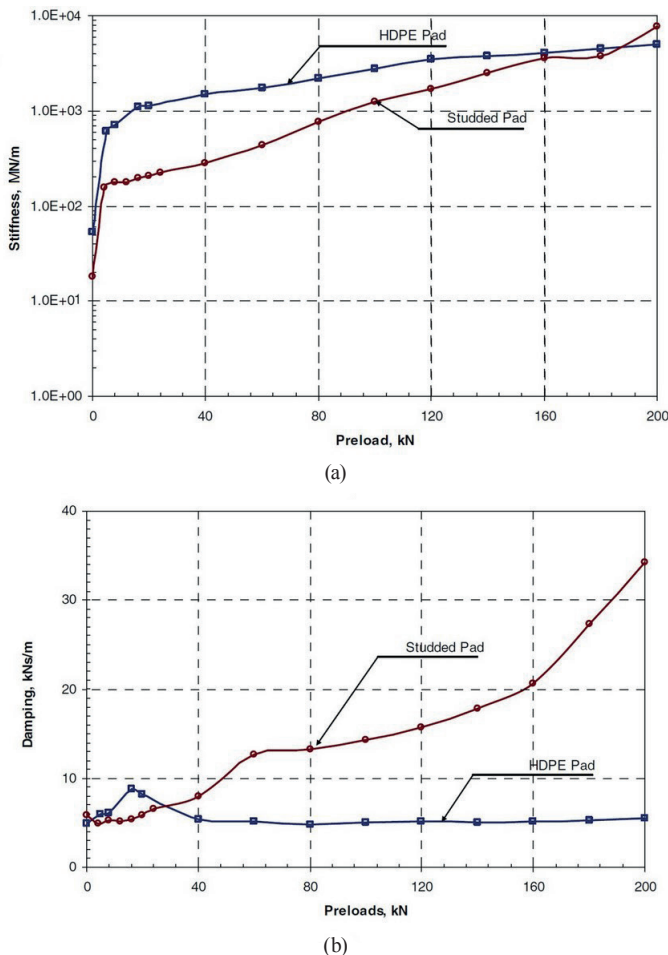

Fig. 3 Dynamic properties of pads: a) stiffness, b) damping. [21]

Dalberg equation [13] is employed to consider non-linear ballast in the modeling:

$$k_b = 22.75 + 2.6 \times 10^8 x_b^2 \quad (1)$$

In which k_b is ballast stiffness (MN/m), and x_b is ballast compressive displacement (m). Dynamic analysis for each pad is carried out in three different scenarios. The first scenario, LP-LB, considers linear behavior of pad and ballast with constant stiffness and damping. In second scenario, NLP-LB, non-linear characteristics are considered for pads, while ballast is linearly modeled. In last scenario, NLP-NLB, both ballast and pad are modeled nonlinearly. All analysis are carried out for an axle load of 10 tons, and speeds varying from 20 to 160 km/h, increasing in steps of 20 km/h.

3 Model verification

The model proposed by Pang [22] is employed. This model studies the contact forces as wheels cross over insulated rail joints. Field tests are carried out employing heavy freight trains with full and empty wagons. Strain gages have mounted at both sides of web rail in right-hand side of the insulated rail joint to measure vertical normal strain. First, full freight wagons with an axle load of 130.47 kN and a speed of 74.49 km/h traveled from left to right and strains are measured. Next, empty wagons with an axle load of 28.9 kN and a speed of 80.6 km/h cross over the joint on the opposite direction from right to left and rail strains are recorded. Figure 4 present the comparison of experimental and numerical results in both traffic conditions. As clearly seen, numerical results have an acceptable agreement with experimental results.

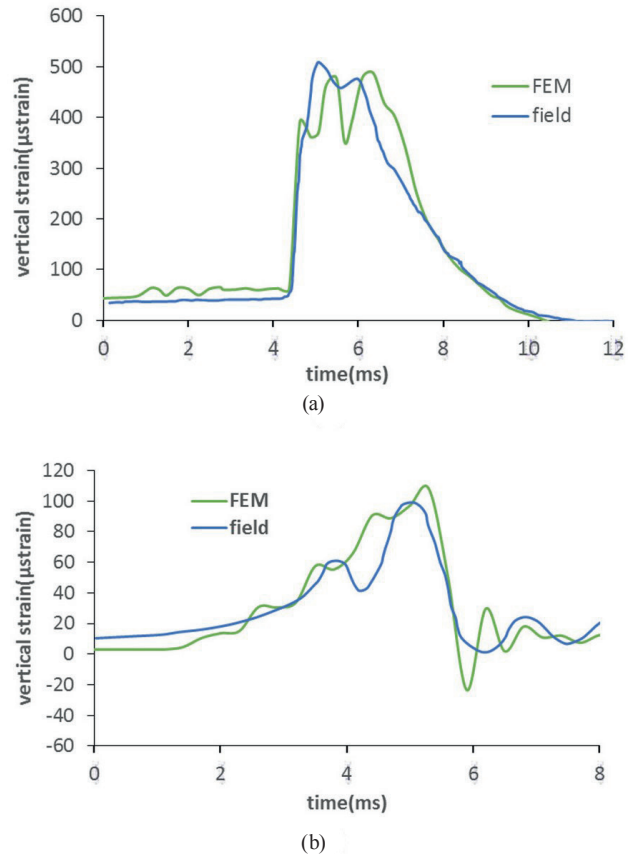

Fig. 4 Comparing experimental and numerical results by train travelling: a) from left to right, b) from right to left

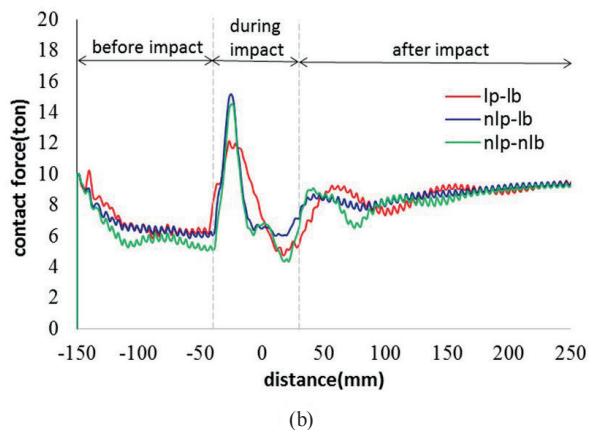
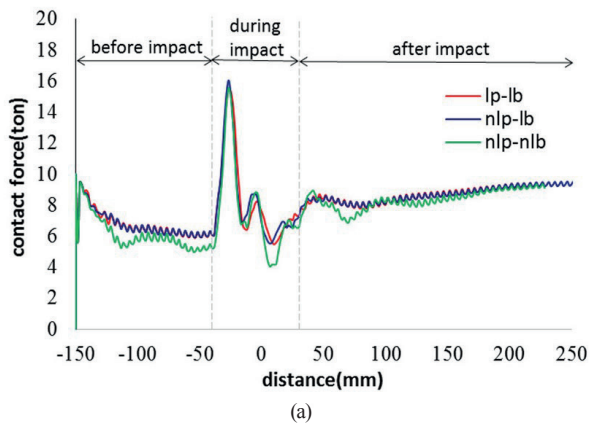

Fig. 5 Contact force time history of a) HDPE pad b) studded pad (v = 20 km/h)

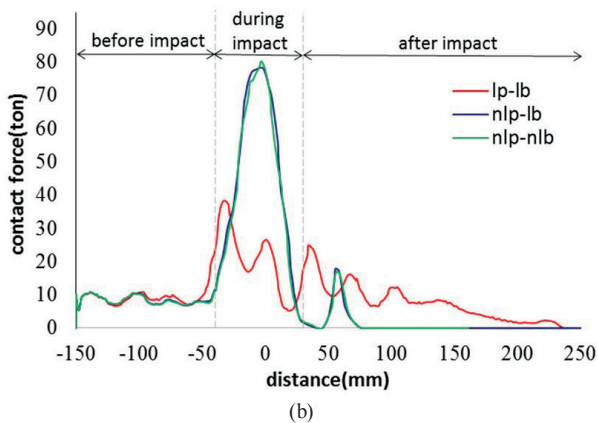
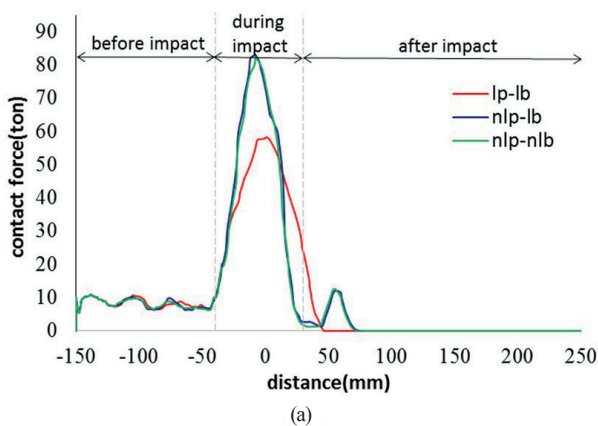

Fig. 6 Contact force time history of a) HDPE pad b) studded pad (v = 160 km/h)

4 Commentary on results of analysis

4.1 Contact forces

Contact forces are the primary dynamic value in dynamic interaction of wheel-rail. Higher contact forces could lead to defects in both the rail and the wheel, while lower forces could increase the risk of derailment. Figures 5 and 6 present the wheel-rail contact force time histories for speeds of 20 and 160 km/h, for both pad types. The horizontal axis is the relative distance of the wheel centre from the position of rail breakage (mm), and vertical axis is the contact force (ton). Contact force signatures consist of three zones. The first zone is when the wheel rolls over the rail before the rail breakage location (before impact), the second zone initiates when the wheel strikes the rail head after the rail breakage location but it doesn't loss contact by the former rail completely (during impact) and in the third zone, the wheel rolls just over the rail which is located after the rail breakage (after impact).

As seen in Figures 5 and 6, as the wheel crosses over the rail breakage, the contact force is significantly increased due to the contact of wheel to the rail, and then the contact force is gradually decreased. In higher speeds, where the impact forces are higher it is followed by wheel-rail contact loss of wheel and rail, which significantly increases the risk of derailment. Moreover, it is concluded that the contact force time histories of non-linear models (NLP-LB and NLP-NLB) are almost identical to each other. Yet, the difference of non-linear and linear models is significant, particularly for higher speed of 160 km/h. The maximum of contact forces for various speeds in three models are presented in Figure 7.

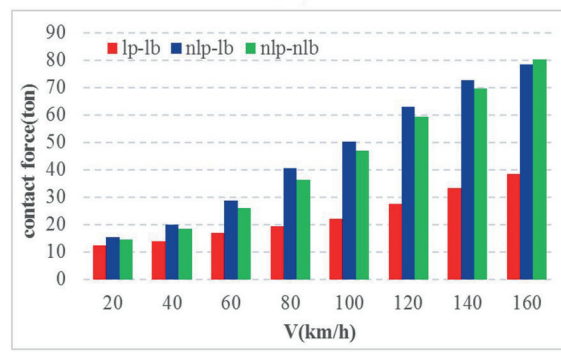
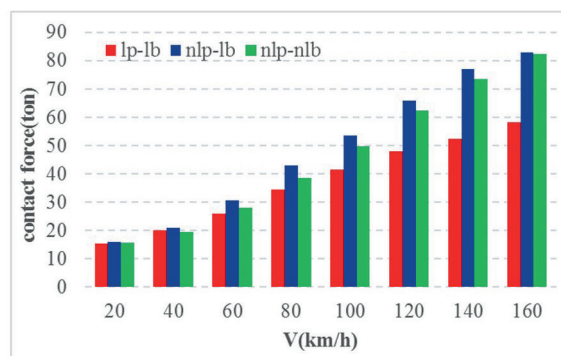

Fig. 7 Effects of behavioral models of material on maximum contact forces for a) HDPE and b) studded pads

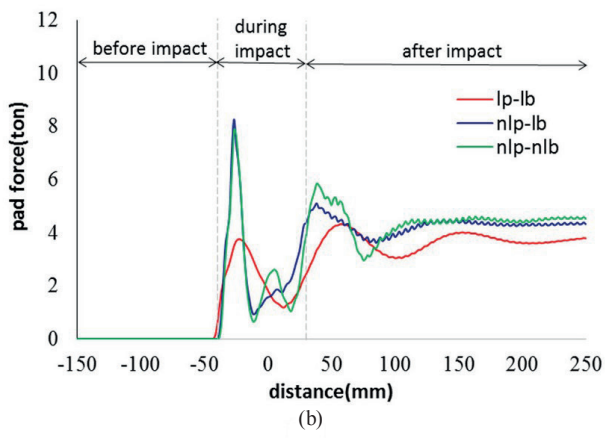
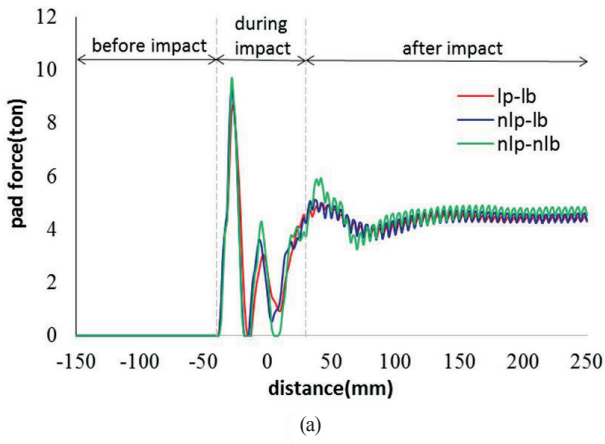

Fig. 8 Pad force time history of a) HDPE pad b) studed pad ($v = 20$ km/h)

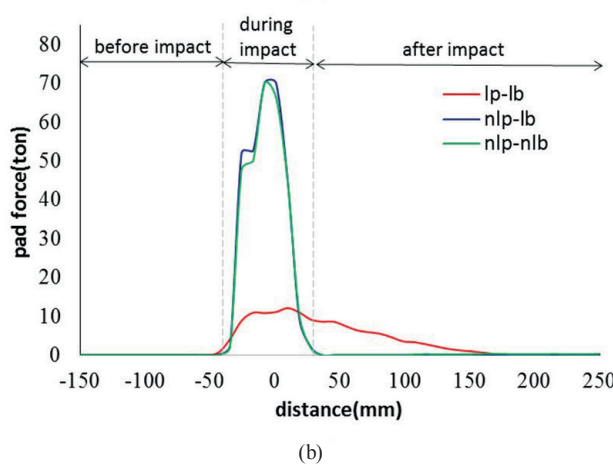
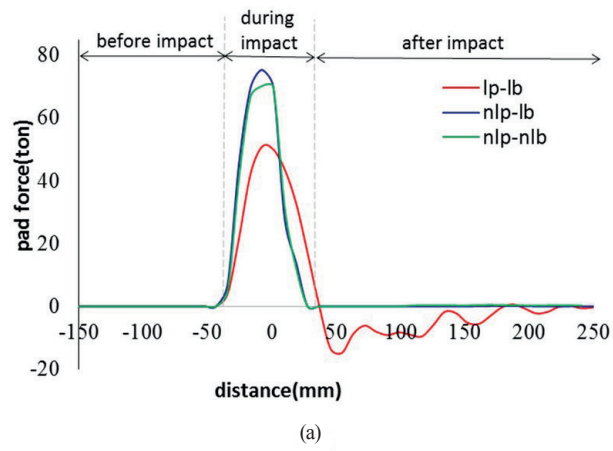

Fig. 9 Pad force time history of a) HDPE pad b) studed pad ($v = 160$ km/h)

According to results, increasing the speed would result in higher wheel-rail contact forces in all three models. In the model with HDPE pads, impact forces are similar for all three models in low speeds of 20–40 km/h, while the difference of linear and non-linear models increases significantly in higher speeds. At a crossing speed of 160 km/h, maximum contact force produced by non-linear model is 41.3% higher than that of linear model.

Moreover, the results suggest that considering nonlinear ballast has no significant effect on contact forces. The difference of maximum contact forces of NLP-LB and NLP-NLB models is less than 10%. For soft studded pads, as presented in Figure 7.b., the linear model underestimates the wheel-rail contact forces, especially for higher speeds. At 160 km/h, impact force produced by LP-LB is 52.4% less than that of NLP-NLB.

4.2 Rail pad forces

Another primary element in track's superstructure is rail pad. As the exerted forces on rail pads increase, it leads to increasing of pads failures and maintenance costs consequently. Figures 8 and 9 present the pad's force time histories for speeds of 20 and 160 km/h, for both pad types. The horizontal axis represents the relative distance of the wheel centre from the position of rail breakage (mm), and vertical axis represents the pad force (ton). Results are almost similar to those of contact forces. For low speed of 20 km/h, forces on HDPE pads are similar for all three models. On the other hand, non-linear model tends to underestimate the pad-forces in higher crossing speeds. For the studded pads, however, the difference of linear and non-linear models is significant, for all crossing speeds.

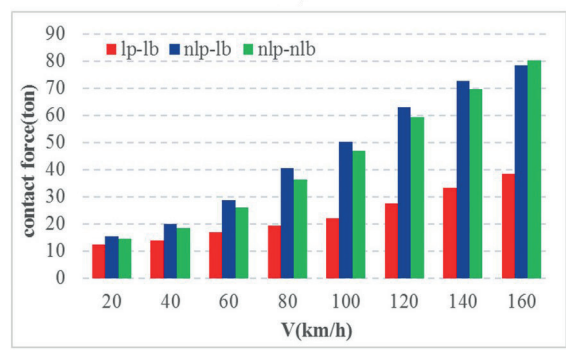
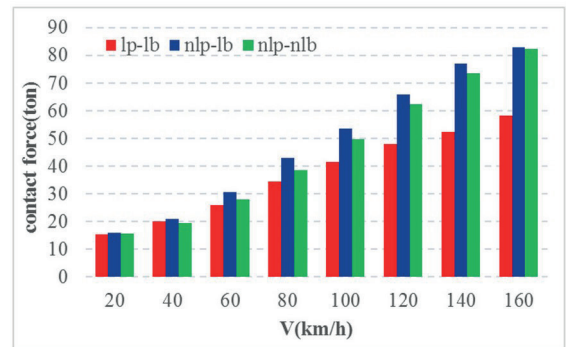

Fig. 10 Effects of behavioral models of material on maximum pad forces for a) HDPE, and b) studed pads

As Fig. 10 suggests, the higher the crossing speed, the higher the pad force, for all three models. For HDPE pads, pad forces produced by non-linear model for speeds of 20 and 160 km/h are respectively 1.1 and 1.4 times larger than those of linear model. For studded pads, these values are 1.8 and 5.8, respectively. As evident, in studded pads, which are considered as soft pads, pad forces produced by linear model are relatively less than those of HDPE pads. While employing non-linear model shows that pad forces in studded pads are almost 22% less than those of HDPE in low speeds, and for higher speeds, they are almost equal.

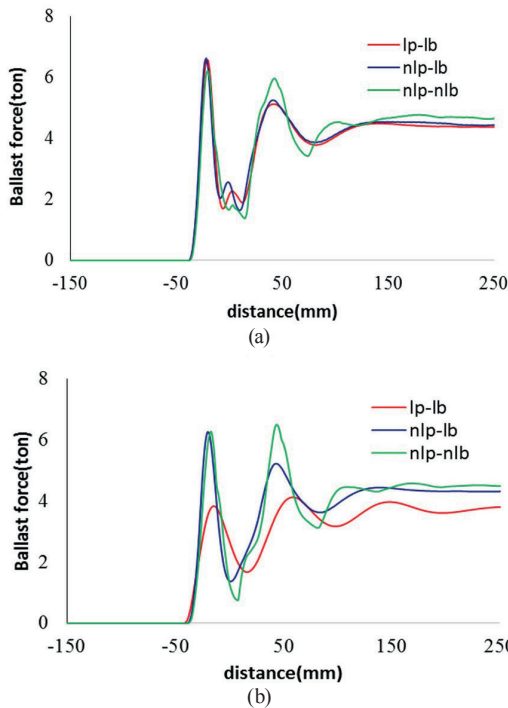

Fig. 11 Ballast force time history of a) HDPE pad b) studded pad ($v = 20 \text{ km/h}$)

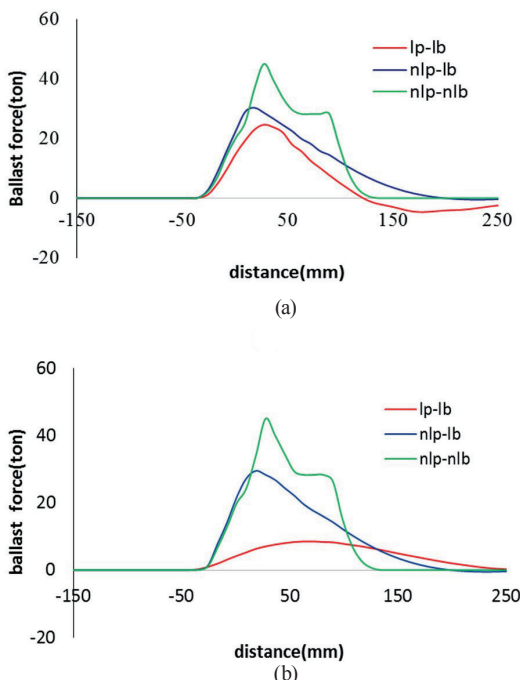

Fig. 12 Ballast force time history of a) HDPE pad b) studded pad ($v = 160 \text{ km/h}$)

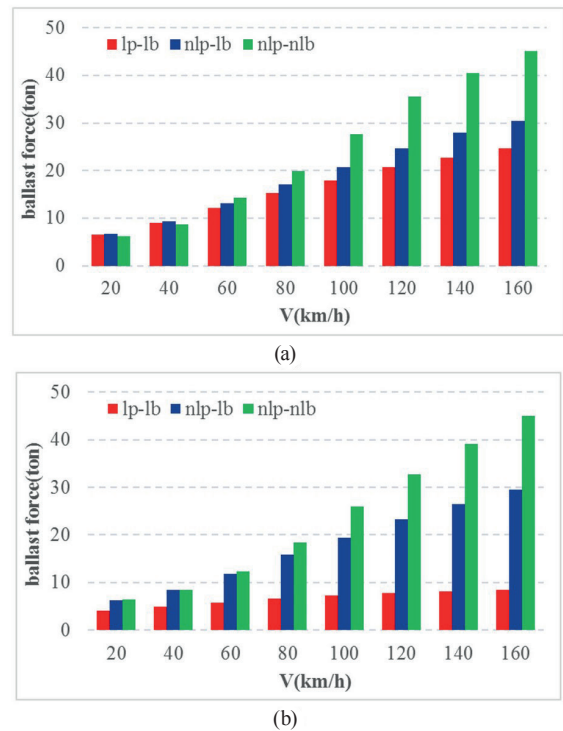

Fig. 13 Effects of behavioral models of material on maximum ballast forces for a) HDPE, and b) studded pads

4.3 Ballast forces

Ballast is also an important element in track's superstructure, and it constitutes largely to the costs of maintenance. An accurate study of ballast forces could produce more accurate results to assess costs of life cycle. In Figures 11 and 12, ballast forces are presented for speeds of 20 and 160 km/h, for two pad types.

For HDPE pad and at a low speed of 20 km/h, the difference of linear and non-linear models is insignificant. Yet, for studded pads, LP-LB model produces lower ballast forces compared to other models.

According to Fig 12, it seems mandatory to employ non-linear ballast models to have an accurate estimation of ballast forces.

For HDPE pads, and at speeds of 20 and 40 km/h, NLP-NLB model produces ballast forces which are respectively 5.3% and 2.1% less than those of LP-LB. For higher crossing speeds, non-linear model produces ballast forces which are comparatively higher than those estimated by linear model. At a crossing speed of 160 m/h, NLP-NLB model estimation of ballast forces is almost 1.83 times larger than that of LP-LB model. (Figure 13.a)

Moreover, it is shown that considering non-linear behavior for pads alone may not result in accurate estimation of ballast forces, and at higher speeds, the difference of NLP-NLB and NLP-LB models is significant. For studded pads, it is concluded that although linear models underestimate ballast forces, the differences of non-linear models for two pads are insignificant.

5 Conclusions

In order to study the effects of considering non-linear behavioral models for superstructure elements on induced forces, particularly in existence of rail discontinuities that increase the wheel-rail contact forces, an impact-contact model is employed. One such discontinuity is rail breakage, which significantly increases the wheel-rail contact forces. In such cases, accurate estimation of wheel-rail forces is of great importance, since it could be used for assessment of derailment probability and procedure of track design, and optimum stiffness for super-structure elements.

Since impact forces on rail could have significant effects on induced forces of super-structure elements, it seems inevitable to employ non-linear behavioral models for these elements. In this regard, three models are developed. Moreover, two types of pads are considered, HDPE and studded, with different stiffness and damping values. Analyses are carried out for speeds varying between 20 and 160 km/h.

Results suggest that for higher crossing speeds, impact forces increase, and employing non-linear behavioral models is mandatory to produce accurate results. Moreover at higher speeds and for both pad types, the wheel-rail contact forces are reduced after the impact force, and risk of derailment is increased. For studded pads, linear model underestimates forces, even at low speeds. However, for HDPE pads, and for impact forces of up to 30 tons, the difference of linear and non-linear models remains below 10%. The difference of maximum contact forces produced by NLP-NLB and NLP-LB models remain below 12%, which suggests that NLP-LB model could be an acceptable replacement for non-linear models.

Forces in pads follow a similar pattern as those of contact forces. The difference of maximum pad forces for HDPE pads produced by non-linear and linear models is limited to 30%, while it is as high as 80% for studded pads. Moreover, it is concluded that employing NLP-LB model overestimates pad forces compared to those of NLP-NLB, and therefore, could be a suitable substitute for such models.

According to results, employing NLP-NLB models is mandatory to get an accurate estimation of ballast forces. For HDPE pads, ballast forces estimated by LP-LB and NLP-LB models are respectively 33% and 45% less than that estimated by nonlinear pad and ballast model. These values are even higher for studded pads, 81% and 35%, respectively

References

- [1] Mosayebi, S-A., Zakeri, J-A., Esmaeili, M. "Some aspects of support stiffness effects on dynamic ballasted railway tracks". *Journal of Periodica Polytechnica Civil Engineering*, 60(3), pp. 427–436. 2016. <https://doi.org/10.3311/PPci.7933>
- [2] Zakeri, J-A., Xia, H. "Sensitivity analysis of track parameters on train-track dynamic interaction". *Journal of Mechanical Science and Technology*, 22(7), pp. 1299–1304. 2008. <https://doi.org/10.1007/s12206-008-0316-x>
- [3] Kaiser, I., Popp, K. "Interaction of elastic wheelsets and elastic rails: modeling and simulations". *Vehicle System Dynamics*, 44(1), pp. 932–939. 2007. <https://doi.org/10.1080/00423110600907675>
- [4] Sun, Y. Q., Dhanasekar, M. "A dynamic model for the vertical interaction of the rail track and wagon system". *International Journal of Solids and Structures*, 39(5), pp. 1337–1359. 2002. [https://doi.org/10.1016/S0020-7683\(01\)00224-4](https://doi.org/10.1016/S0020-7683(01)00224-4)
- [5] Zhai, W., Cai, Z. "Dynamic interaction between a lumped mass vehicle and a discretely supported continuous rail track". *Computers and Structures*, 63 (5), pp. 987–997. 1997. [https://doi.org/10.1016/S0045-7949\(96\)00401-4](https://doi.org/10.1016/S0045-7949(96)00401-4)
- [6] Newton, S. G., Clark, R. A. "An investigation into the dynamic effects on the track of wheel flats on railway vehicles". *Journal of Mechanical Engineering Science*, 21(4), pp. 287–297. 1979. https://doi.org/10.1243/JMES_JOUR_1979_021_046_02
- [7] Jin, X., Wen, Z., Wang, K., Xiao, X. "Effect of passenger car curving on rail corrugation at a curved track". *Wear*, 260(6), pp. 619–633. 2006. <https://doi.org/10.1016/j.wear.2005.03.016>
- [8] Nielsen, J. C. O., Johansson A. "Out of round railway wheels a literature survey". *Journal of Rail and Rapid Transit*, 214(2), pp. 79–91. 2000. <https://doi.org/10.1243/0954409001531351>
- [9] Andersson, C., Dahlberg, T. "Wheel/rail impacts at a railway turnout crossing". *Journal of Rail and Rapid Transit*, 212(2), pp. 123–134. 1998. <https://doi.org/10.1243/0954409981530733>
- [10] Wu, T. X., Thompson, D. J. "On the impact noise generation due to a wheel passing over rail joints". *Journal of Sound and Vibration*, 267(3), pp. 485–496. 2003. [https://doi.org/10.1016/S0022-460X\(03\)00709-0](https://doi.org/10.1016/S0022-460X(03)00709-0)
- [11] Dukkipati, R. V., Dong, R. "The Dynamic Effects of Conventional Freight Car Running over a Dipped-joint". *Vehicle System Dynamics*, 31(2), pp. 95–111. 1999. <https://doi.org/10.1076/vesd.31.2.95.2095>
- [12] Suarez, B., Rodriguez, P., Vazquez, M., Fernandez, I. "Safety assessment of underground vehicles passing over highly resilient curved tracks in the presence of a broken rail". *Vehicle System Dynamics*, 50(1), pp. 59–78. 2012. <https://doi.org/10.1080/00423114.2011.563859>
- [13] Gonzalez, F. J., Suarez, B., Paulin, J., Fernandez, I. "Safety assessment of underground vehicles passing over highly resilient straight tracks in the presence of a broken rail". *Journal of Rail and Rapid Transit*, 222(1), pp. 69–84. 2008. <https://doi.org/10.1243/09544097JRRRT128>
- [14] Wu, T. X., Tompson, D. "The effect of track non-linearity on wheel/rail impact". *Journal of Rail and Rapid Transit*, 218(1), pp. 1–15. 2004. <https://doi.org/10.1243/095440904322804394>
- [15] Dahlberg, T. "Dynamic interaction between train and non-linear railway track model". In: *International conference (EURODYN)*, 2–5 September, Munich, Germany; 2002.
- [16] Johansson, A., Nielsen, J. C. O. "Out-of-round railway wheels-wheel-rail contact forces and track response derived from field tests and numerical simulations". *Journal of Rail and Rapid Transit*, 217(2), pp. 135–146. 2003. <https://doi.org/10.1243/095440903765762878>
- [17] Uzzal, R. U. A., Ahmed, A. K. W., Bhat, R. B. "Modelling, validation and analysis of a threedimensional railway vehicle-track system model with linear and nonlinear track properties in the presence of wheel flat". *Vehicle System Dynamics*, 51(11), pp. 1695–1721. 2013. <https://doi.org/10.1080/00423114.2013.822987>
- [18] Zakeri, J. A. "Statistical analysis of rail breakage and rail welding failures in Iranian railways". In: *Railway Engineering - 2005*, London, UK, 29–30 June, 2005.

- [19] Sawley, K., Reiff, R. "An assessment of Rail track's methods for managing broken and defective rails". Transportation Technology Center, Inc. A subsidiary of the Association of American Railroads Pueblo, Colorado USA . 2000.
- [20] Liu, X., Saat M. R., Barkan, C. P. L. "Analysis of Causes of Major Train Derailment and Their Effect on Accident Rates". *Journal of the Transportation Research Board*, 2289(1), pp. 154–163. 2012. <https://doi.org/10.3141/2289-20>
- [21] Kaewunruen, S., Remennikov, A. M. "An alternative rail pad tester for measuring dynamic properties of rail pads under large preloads". *Experimental Mechanics*, 48(1), pp. 55–64. 2008. <https://doi.org/10.1007/s11340-007-9059-3>
- [22] Pang, T. "Studies on Wheel/Rail Contact – Impact Forces at Insulated Rail Joints". Master of Engineering Thesis. Central Queensland University. 2007. <https://trove.nla.gov.au/version/181446652>