

The Advantages of Fuzzy Control for Heat Pumps Systems

Róbert Sánta^{1*}, János Simon^{2*}, László Garbai³

¹ Department of Mechanical Engineering and Material Sciences, University of Dunaújváros, Táncsics Mihály u. 1/a, H-2400 Dunaújváros, Hungary

² Department of Mechatronics and Automation, Faculty of Engineering, University of Szeged, Moszkvai krt. 9, H-6725 Szeged, Hungary

³ Department of Building Services and Process Engineering, Faculty of Mechanical Engineering, Budapest University of Technology and Economics, Műegyetem rkp. 3, H-1111 Budapest, Hungary

* Corresponding author, e-mail: santar@uniduna.hu

Received: 30 May 2023, Accepted: 22 June 2023, Published online: 07 July 2023

Abstract

Application of fuzzy control has been observed in various engineering fields due to its ability to handle uncertainties and non-linearities. In this study, the advantages of using fuzzy control in heat pump systems are being investigated. Specifically, the performance of a heat pump system with a conventional proportional-integral-derivative (PID) controller is being compared to that of a heat pump system with a fuzzy logic controller. It has been demonstrated by the results that the fuzzy control-based heat pump system offers better performance in terms of energy efficiency, temperature control, and overall system stability. This study contributes to the understanding of the potential benefits of fuzzy control-based heat pump systems and provides a foundation for further research in this area.

Keywords

heat pump, fuzzy, coefficient of performance (COP), control, LabVIEW

1 Introduction

Fuzzy control, on the other hand, is a powerful method for handling such complexities. This study aims to investigate the advantages of using fuzzy control in heat pump systems. Global energy demand is expected to grow significantly in the coming decades due to population growth, urbanization, and economic development. This study presents a projection of global energy demand until 2050 based on historical trends, population and economic growth rates, and assumptions about technology and policy. Our results indicate that energy demand will continue to increase, with most of the growth coming from developing countries. The implications of this growth on energy security, climate change, and sustainable development are also discussed. Energy is an essential input for economic development, social progress, and human well-being. However, energy consumption also has significant environmental and social impacts, including greenhouse gas emissions, air pollution, and resource depletion. The global energy system is undergoing a profound transformation due to technological innovation, policy changes, and evolving consumer preferences. In this context, it is important to understand the future trajectory

of energy demand to inform policy decisions and investment strategies. The share of renewable energy sources will increase, but fossil fuels will remain dominant for the foreseeable future. The following are the key contributions of this paper:

- A fuzzy logic controller for a ground water heat pump is proposed.
- The control performance of the fuzzy logic controller is verified through simulation and found to be comparable to conventional PIDs (which are still used in most facilities) on the target hardware.

2 Related work

In designing and operating any equipment, including heat pumps, it is a legitimate demand – and a fundamental requirement in the 21st century – that the equipment fits optimally to the consumption needs. This means that the establishment and use of the equipment with parameters that result in optimum performance and minimal operational costs must be done. In the operation of a heat pump system, the task is to produce the necessary heat to meet consumer demands at minimal operational costs. When

investing in a system, it must be kept in mind and included in the objective function of the design that the system is built with parameters that provide the required heating performance with prescribed reliability to meet consumer needs, while minimizing the joint annual costs of investment and operation.

Several studies have investigated the application of fuzzy control in heat pump systems. The following related work section discusses the research papers related to the application of different control and optimization techniques in heat pump systems. Wang et al. [1] proposed an observer-based composite adaptive fuzzy control for non-strict-feedback systems with actuator failures. The control strategy was based on the composite adaptive fuzzy control and the observer-based fault diagnosis techniques, which were used to deal with the actuator faults and ensure the stability of the system. Shao et al. [2] presented a study on the thermal performance analysis of a new refrigerant-heated radiator coupled with air-source heat pump heating system. They carried out experiments to investigate the thermal performance of the system under different operating conditions and compared it with a conventional heating system. Luo et al. [3] provided a review of the application of ground source heat pumps (GSHP) in China. The review focused on the development of GSHP technology, the performance of GSHP systems, and the challenges faced during the implementation of GSHP systems in China. Nyers and Nyers [4] investigated the performance of heat pump condensers in the heating process of buildings using a steady-state mathematical model. They studied the impact of different operating parameters on the performance of the condenser and suggested ways to improve the efficiency of the system. Santa et al. [5] proposed an optimization model for heat pump systems. The model was based on a combination of linear programming and mixed-integer linear programming techniques and was used to optimize the performance of the heat pump system by selecting the optimal operating conditions. Nyers and Nyers [6] proposed a method for enhancing the energy efficiency of heat pump systems by energy optimization. The proposed method was based on the energy balance equation and was used to calculate the coefficient of performance (COP) of the heat pump system under different operating conditions. Nguyen and Le [7] presented a study on structural fuzzy reliability analysis using classical reliability theory. The proposed approach was based on the theory of fuzzy assemblies and was used to analyse the reliability of complex engineering systems.

3 Materials and methods

The entire heat pump system was broken down into its individual components and input and output variables, decision variables, and losses for each component were provided in the system theoretical description. By mathematically linking the balance equations for each system element, it becomes possible to analyze the entire system with a unified input-output analysis and execute optimization by minimizing the operation or construction objective function [8]. In our work, the inputs for a given consumer heat demand, as well as how to satisfy this demand with minimal cost by mediating energy and material flows, are being sought.

3.1 The mathematical model of the heat pump

The COP of the heat pump system can be determined by adding the power consumption of the primary and secondary circulating pumps to the power consumed by the compressor of the heat pump.

$$COP = \frac{\dot{Q}_c}{P_k + P_p + P_s} \tag{1}$$

The connection diagram of the ground source heat pump heating system using boreholes is illustrated in Fig. 1, which includes the main mechanical components necessary for the operation of the system [9].

The mathematical model describes the operation of the heat pump is, thermal and mass changes are described in relation to time. The mathematical models proposed for heat exchangers have been described by coupled differential equations, whereas the compressor and expansion valve models are grouped parameters.

3.1.1 The mass balance equations of the heat source

The heat transfer of a BHE in the ground is described by two parameters: effective thermal conductivity which describes the mean thermal conductivity of the surroundings for borehole, λ_{eff} ; and borehole resistance which describes heat transfer between pipes and borehole wall (R_b). The parameters of the soil thermal conductivity and the borehole thermal

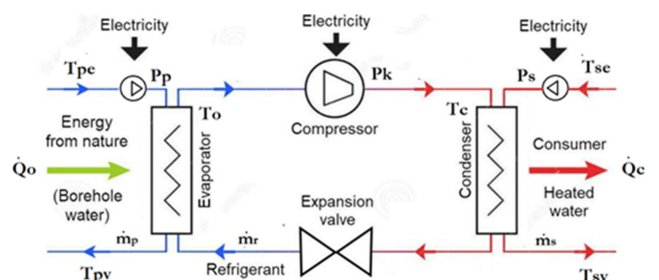

Fig. 1 The schematic diagram of the heat pump system

resistance is usually conducted based on the infinite line source model. Garbai and Méhes [9] have shown that temperature in a soil mass subjected to a heat flux per unit length (q) can be approximated from Eq. (2):

$$T_g = \frac{Q}{4 \times \pi \times \lambda_{\text{ground}} \times H} \times E_1 \times \left(\frac{r_b^2}{4 \times a_{\text{ground}} \times t} \right) + \frac{Q}{H} \times R_b + T_{ug}, \quad (2)$$

where:

$$E_1 = \int_0^\infty \frac{5^{-u}}{u} du, \quad (3)$$

$$a_{\text{ground}} = \frac{\lambda_{\text{ground}}}{c_{\text{ground}}}, \quad (4)$$

$$E_1 = -\gamma - \ln \left(\frac{x + A \times x - B \times x^2 + D \times x^3}{-E \times x^4 + F \times x^5} \right), \quad (5)$$

where: $A = 0.99999193$, $B = 0.24991055$, $D = 0.05519968$, $E = 0.00976004$, $F = 0.00107857$, $\gamma = 0.5772$.

$$x = \frac{r_b^2}{4 \times a_{\text{ground}} \times t} \quad (6)$$

3.1.2 The basic equations of the heat exchangers

The governing law of fluid motion is derived using a control volume approach. In this case, the control volume is fixed for simplicity. During the analysis of a control volume problem, the three laws are always valid:

1. Refrigerant:

- Conservation of mass:

$$\frac{\partial \rho_r}{\partial t} + \frac{\partial(\rho_r \times w)}{\partial z} = 0. \quad (7)$$

- Conservation of energy:

$$\frac{\partial(\rho \times h_o)}{\partial t} + \frac{\partial(\rho \times w \times h_o)}{\partial z} = \frac{\partial p}{\partial t} + \dot{q}_b \times \frac{K_b}{A_b}. \quad (8)$$

- Conservation of momentum:

$$\frac{\partial(\rho \times w)}{\partial t} + \frac{\partial(\rho \times w \times w + p)}{\partial z} + fx = 0, \quad (9)$$

where fx is the effect of shear stress on the fluid and is the pressure drop of the refrigerant and can be denoted as $\partial p / \partial z$.

2. The heat transfer equation between the refrigerant and the pipe wall:

- The wall has negligible thickness: $d_o = d_i$ so it is $T_{\text{wall},o} = T_{\text{wall},i} = T_{\text{wall}}$:

$$\rho_{\text{wall}} \times cp_{\text{wall}} \times n \times A_{\text{wall}} \times \frac{\partial T_{\text{wall}}}{\partial t} = \dot{q}_o - \dot{q}_i, \quad (10)$$

where the cross section of the pipe wall:

$$A_{\text{wall}} = (d_o^2 - d_i^2) \times \frac{\pi}{4}, \quad (11)$$

$$\dot{q}_o = \alpha_w \times d_o \times \pi \times n \times (T_w - T_{\text{wall}}), \quad (12)$$

$$\dot{q}_i = \alpha_r \times d_i \times \pi \times n \times (T_{\text{wall}} - T_r). \quad (13)$$

3. The heat transfer equation between the water and the pipe wall:

$$\begin{aligned} & \rho_{\text{wall}} \times cp_{\text{wall}} \times n \times A_{\text{wall}} \times \frac{\partial T_{\text{wall}}}{\partial t} \\ &= -\dot{V}_w \times \rho_{\text{wall}} \times cp_{\text{wall}} \times \frac{\partial T_{\text{wall}}}{\partial z} \\ & - \alpha_w \times d_o \times \pi \times n \times (T_w - T_{\text{wall}}). \end{aligned} \quad (14)$$

The evaporator and condenser are shown together, as the basic equations of the two heat exchangers are identical, but with different signs. In both heat exchangers, the refrigerant flows inside the pipes, while the cooled/heated fluid flows on the shell side.

The model considers, first section is the evaporation – two-phase flow and the second section superheated section single phase flow, while in the condenser the first section is superheated section and the second is the condensation section. Different correlations of heat transfer and pressure drop were used in each section and are summarized in Tables 1 and 2 [10–14].

Table 2 summarizes the correlations to calculate the pressure drop of a single-phase and two-phase refrigerant and the water pressure drop on the evaporator shell side.

3.1.3 The mass balance equations of the compressor

The mass balance equations of the compressor can be seen in Section 3.1.3.

The mass flow rate of the refrigerant:

$$\dot{m}_r = \frac{\lambda \times \dot{V}_{\text{geo}}}{v_{\text{vap}}}. \quad (15)$$

The theoretical power consumption of the compressor:

$$P = W \times \dot{m}_r. \quad (16)$$

The actual power consumption of the compressor is as follows in Eq. (17):

$$P = W \times \dot{m}_r \times \frac{1}{\eta_i} \times \frac{1}{\eta_m}, \quad (17)$$

where η_i is the isentropic efficiency of the compressor.

$$\eta_i = \frac{h_{2s} - h_1}{h_2 - h_1} \quad (18)$$

While η_m expresses the efficiency of the driving motor, which can be assumed to be in the range of 0.95–0.98.

3.1.4 The mass balance equation of the expansion valve

The heating capacity of the expansion valve can be determined by Eq. (19):

$$\dot{Q}_{\text{exp}} = \dot{m}_r \times \dot{q}_o. \quad (19)$$

3.1.5 The mass balance equations of the heat sinks

The heat pump operates at the dimensioning point. If the customer's demand for heat differs from the design, the heat pump operates with on-off control. Below, the balance equations of the consumption system are presented, which are adapted to the description of the temporal changes of the so-called concentrated parameters. These are differential equations which can only be resolved by numeric methods. By solving these differential equations, it is possible to track how the water temperature circulated in the heating system and the temperature of the living space changes during the regulation of the heat pump and when using a buffer tank.

Heat balance of the heating system:

$$\frac{d}{d\tau} \left(\dot{m}_s \times c_s \times \frac{T_{se} + T_{sv}}{2} \right) = \dot{Q}_{HS} - \dot{Q}_{\text{cons}}. \quad (20)$$

Table 1 Correlations for heat transfer coefficient

Region	Tube side heat transfer correlation
Single phase flow: Dittus and Boelter [10]	$\alpha_r = 0.023 \times \text{Re}^{0.8} \times \text{Pr}^{0.3} \times \frac{\lambda}{d_i}$ $\alpha_r = \max(\alpha_{nb}, \alpha_{cb})$ $\alpha_{nb} = (0.6683 \times Co^{-0.2} f(Fr_{lo}) + 1058 \times Bo^{0.7} \times F_f) \times \alpha_i$ $\alpha_{cb} = (1.136 \times Co^{-0.9} f(Fr_{lo}) + 667.2 \times Bo^{0.7} \times F_f) \times \alpha_i$
Two phase flow, evaporation: Kandlikar [11]	$f(Fr_{lo}) = (25 \times Fr_{lo})^{0.3}$ for horizontal tubes with $Fr_{lo} \leq 0.04$ where α_i is calculated by Eq. (21). The numerical value of F_f is 1.63 for R134a.
Two phase flow, condensation: Shah [12]	$Bo = \frac{q}{Gi_{lg}} Co = \left(\frac{1-x}{x} \right)^{0.8} \left(\frac{q}{Gi_{lg}} \right)^{0.5} Fr_{lo} = \frac{G^2}{\rho_l^2 \times g \times d_i}$ $\alpha_p = \alpha_i \times \left[(1-x)^{0.8} + \frac{3.8 \times x^{0.76} \times (1-x)^{0.04}}{\text{Pr}^{0.38}} \right]$ $\alpha_i = 0.023 \times \frac{\lambda_l}{d} \times \text{Re}_l^{0.8} \times \text{Pr}^{0.43}$
	Shell side heat transfer correlation
	$\alpha = \alpha_{id} \times J_c \times J_L \times J_B \times J_S \times J_\mu$ Idealized heat transfer coefficient α_i $\alpha_{id} = j \times c_p \times m \times \text{Pr}^{-2/3} S_m^{-1}$ Baffle cut correction factor: $J_c = 0.55 + 0.72 \times F_c$ Baffle leakage correction factor: $J_L = 0.44 \times (1 - r_s) + [1 - 0.44 \times (1 - r_s)] \exp(-2.2 \times r_m)$ Bundle bypass correction factor: $J_B = \exp(-C_{bh} \times F_{sbp} \times (1 - \sqrt{2 \times r_{ss}}))$.
Single phase flow: Bell [13]	The empirical factor $C_{bh} = 1.35$ for laminar flow and $C_{bh} = 1.25$ for transition and turbulent flows. Unequal baffle spacing correction factor:
	$J_S = \frac{(N_b - 1) + \left(\frac{L_{bi}}{L_{bc}} \right)^{1-n} + \left(\frac{L_{bo}}{L_{bc}} \right)^{1-n}}{(N_b - 1) + \left(\frac{L_{bi}}{L_{bc}} \right) + \left(\frac{L_{bo}}{L_{bc}} \right)}$
	Wall viscosity correction factor: $J_\mu = \left(\frac{T_w + 273}{T_{\text{wall}} + 273} \right)^m$

Table 2 Pressure drops correlations [5]

Region	Tube side pressure drop correlation
Single and two-phase flow: Grönnerud [14]	$\frac{\Delta p}{dz} = \Phi \times \left(\frac{\Delta p}{dz} \right)_l$
	$\Phi = 1 + \left[\frac{dp}{dz} \right]_{Fr} \times \left[\frac{\rho_l / \rho_v}{(\rho_l / \rho_v)^{0.25}} - 1 \right]$
	$\left[\frac{dp}{dz} \right]_{Fr} = f_{Fr} \times \left[x + 4 \times (x^{1.8} - x^{10} \times f_{Fr}^{0.5}) \right]$
	$f_{Fr} = Fr^{0.3} + 0.0055 \times \left[\ln \frac{1}{Fr} \right]^2$
	$\left(\frac{dp}{dz} \right)_l = \frac{2 \times f_{wall} \times G^2}{d_i \times \rho_l}$
	$f_{wall} = \frac{0.316}{Re^{0.25}}$

Shell side pressure drop correlation

The pressure drop across the shell side:

$$\Delta p_s = \left[(N_b - 1) \times \Delta p_c \times R_b + N_b \times \Delta p_w \right] \times R_L + 2 \times \Delta p_c \times R_b \times \left(1 + \frac{N_{cw}}{N_c} \right).$$

The ideal crossflow pressure drop through one baffle space is obtained with the use of Eq. (36).

$$\Delta p_c = (1.5 + N_c \times 0.495) \times \left(\frac{\rho \times V^2}{2} \right)$$

The window zone pressure drop for $Re > 100$, $\Delta p_w = \frac{(2 + 0.6 \times N_{cw}) \Delta \dot{m}^2}{2 \times S_m \times S_w \times \rho}$

Single phase flow: Bell [13]

The number of effective crossflow rows in the window zone:

$$N_{cw} = \frac{0.8 \times L_c}{P_p}, \quad N_c = \frac{d_o \times (1 - 2 \times L_c / D_i)}{P_p}$$

The window flow is obtained with the use of Eq. (38)

$$S_w = \frac{D_i^2}{4} \times \left[\cos^{-1} D_b - D_b \times (1 - D_b^2)^{1/2} \right] - \frac{n}{8} \times (1 - F_i) \times \pi \times D^2$$

$$D_b = \frac{D_i - 2 \times L_c}{D_i}$$

The heat balance of the room:

$$\begin{aligned} \frac{d}{d\tau} (\dot{m}_{air} \times c_{air} \times T_b) &= k_{rad} \times A_{rad} \times \left(\frac{T_{se} + T_{sv}}{2} - T_b \right) \\ &- k_{TRI} \times A_{TRI} \times (T_b - T_K) - \rho_{air} \times \dot{V}_{air} \times c_{air} \times (T_b - T_K), \end{aligned} \quad (21)$$

Heat transfer delivered by heating system:

$$T_{ave} = \frac{T_{se} + T_{sv}}{2}. \quad (24)$$

$$\begin{aligned} \frac{d}{d\tau} \left(\dot{m}_s \times c_s \times \frac{T_{se} + T_{sv}}{2} \right) &= \dot{Q}_{HS} - k_{rad} \times A_{rad} \times \left(\frac{T_{se} + T_{sv}}{2} - T_b \right), \end{aligned} \quad (22)$$

By combining Eqs. (23) and (24):

$$\frac{d}{d\tau} T_{ave} = \frac{\dot{Q}_{HS}}{\dot{m}_s} - \frac{k_{rad} \times A_{rad}}{\dot{m}_s} \times T_{ave} + \frac{k_{rad} \times A_{rad}}{\dot{m}_s} \times T_b, \quad (25)$$

$$\begin{aligned} \frac{d}{d\tau} T_{ave} = & \frac{\dot{Q}_{HS}}{\dot{m}_s} - \frac{k_{rad} \times A_{rad}}{\dot{m}_{air} \times c_{air}} \times (T_{ave} - T_b) - \frac{k_{TR} \times A_{TR}}{\dot{m}_{air} \times c_{air}} \\ & \times (T_b - T_K) - \frac{\dot{m}_{air} \times c_{air}}{\dot{m}_{air} \times c_{air}} \times (T_b - T_K) = \frac{k_{rad} \times A_{rad}}{\dot{m}_{air} \times c_{air}} \times T_{ave} \\ & + \left(\frac{k_{rad} \times A_{rad}}{\dot{m}_{air} \times c_{air}} - \frac{k_{TR} \times A_{TR}}{\dot{m}_{air} \times c_{air}} - \frac{\dot{m}_{air} \times c_{air}}{\dot{m}_{air} \times c_{air}} \right) \times T_b \\ & + \left(\frac{k_{TR} \times A_{TR}}{\dot{m}_{air} \times c_{air}} \times T_K + \frac{\dot{m}_{air} \times c_{air}}{\dot{m}_{air} \times c_{air}} \times T_K \right). \end{aligned} \tag{26}$$

Taking the coefficients ($a_{11} - a_{23}$) into account with the correct sign, the equations have the following form can also be written in [15]:

$$\frac{d}{d\tau} T_{ave} = a_{11} \times T_{ave} + a_{12} \times T_b + a_{13}, \tag{27}$$

$$\frac{d}{d\tau} T_b = a_{21} \times T_{ave} + a_{22} \times T_b + a_{23}. \tag{28}$$

Initial condition now $\tau = 0$:

$$T_{ave} = T_{ave,0} = \frac{T_{se0} + T_{sv0}}{2}, T_b = T_{b0}, \tag{29}$$

$$T_k = T_{k0} = const.$$

The solution can be obtained using the finite difference method in such a way that to substitute the initial values into the Eq. (27), thus obtaining a new value, with which the Eq. (28) is calculated.

3.1.6 Partial derivative of the circulation pump effective power

The partial derivative of the effective power of the circulation pump, with respect to the mass flow rate of warm water is [6]:

$$\frac{\partial P_{cp,e}}{\partial \dot{m}_{cp}} = \frac{\partial (k_p \times \dot{m}_{cp}^3)}{\partial \dot{m}_{cp}} = k_p \times 3 \times \dot{m}_{cp}^2. \tag{30}$$

3.2 Optimal operation of the heat pump system

In Section 3.2, the general system-theoretical decision models for the operation of heat pump heating systems have been compiled. The decision models are optimization

models that describe the mathematical relationship between the input and output of system elements, decision variables, and the objective function that directs the decisions [16]. The compiled model shown in Fig. 2 contains decision stages. These stages illustrate the individual components of the heating system, which are as follows:

- consumer,
- secondary circuit,
- condenser,
- compressor,
- evaporator,
- primary circuit,
- ground source.

The relationship between the individual stages is ensured by the input, output, and decision variables and the transformation equations. A separate input-output white-box model has been established to describe the operation of the operating system, which is shown in Fig. 2.

During the optimization of the operation of existing systems, the decision variables controlling the operation are as follows:

- at heat source: primary - cooling fluid mass flow rate (\dot{m}_p), flow temperature of primary fluid (T_{pe}),
- at the evaporator: mass flow rate of refrigerant (\dot{m}_r),
- at the compressor: condensation temperature (T_c) and evaporation temperature (T_o),
- at the consumer: mass flow rate of secondary – heating water (\dot{m}_s), flow temperature of heating water (T_{se}).

In general, most designed systems include a buffer tank whose task is to ensure intermittent operation and to equalize the performance of the heat pump and the current heat demand of the consumer. The heating system is connected to this buffer tank and draws heat from it. The heating system temperature steps roughly correspond to the temperature steps used on the secondary side of the heat pump. Most heat pumps available on the market include a built-in control unit. This control unit monitors the temperature prevailing in the buffer tank. When the temperature of the tank reaches the set value, the heat

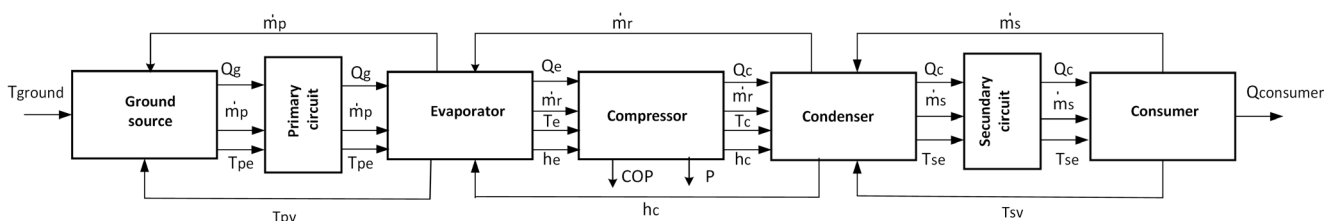

Fig. 2 Decision system theoretical scheme of a functioning heat pump system

pump stops [17]. The controller contains several heating curves, with different tank temperatures corresponding to different external temperatures. In more complex controllers, the control is similar, but the controller - in a learning manner – selects and decides which heating curve to use for the heat pump. The system also considers the internal temperature values sensed by the external environmental and room thermostats.

4 Fuzzy logic-based control system of the heat pump

In Section 4, a new control option is presented for operating systems where the optimal operation of the system is sought. In determining the optimum, the method presented examines the change in COP values corresponding to each primary and secondary mass flow if the desired consumer demand is less than the design. The electricity consumption cost of the primary and secondary system circulation is also included in the optimization objective function [18]. The development of the method allows us to compare the existing regulation and regulation based on the presented method. Optimization of existing system operation means finding the operating parameters – depending on consumer needs – with which the operating costs of the system are minimal. An experiment to optimize the performance of a heat pump system with a fuzzy logic controller was conducted. The fuzzy logic controller was designed based on the Mamdani method. The performance of the system was evaluated in terms of energy efficiency, temperature control accuracy, and system stability under varying operating conditions (see Fig. 3).

The feedforward-feedback control principle of a geothermal-source heat pump system involves using both feedforward and feedback control techniques to regulate

the operation of the system. In this type of control system, the feedforward control is used to predict the energy requirements of the building based on external weather conditions, time of day, and other factors, and then adjust the heat pump operation accordingly. This helps to maintain the desired temperature inside the building while minimizing the energy consumption of the heat pump. The feedback control, on the other hand, uses sensors to measure the actual temperature inside the building and adjust the heat pump operation to maintain the desired temperature. This helps to compensate for any discrepancies between the predicted energy requirements and the actual energy required to maintain the desired temperature. The feedforward-feedback control principle of a geothermal-source heat pump system can be implemented using a control algorithm that combines both techniques. The algorithm typically includes the following steps:

- collect weather data and other external factors that affect the energy requirements of the building,
- use this data to predict the energy requirements of the building over the next few hours,
- use the predicted energy requirements to adjust the operation of the heat pump, such as adjusting the flow rate or temperature setpoint,
- continuously monitor the actual temperature inside the building using sensors,
- use feedback control to adjust the heat pump operation to maintain the desired temperature.

By combining both feedforward and feedback control techniques, the geothermal-source heat pump system can achieve high levels of energy efficiency and precise temperature control, even under varying external conditions.

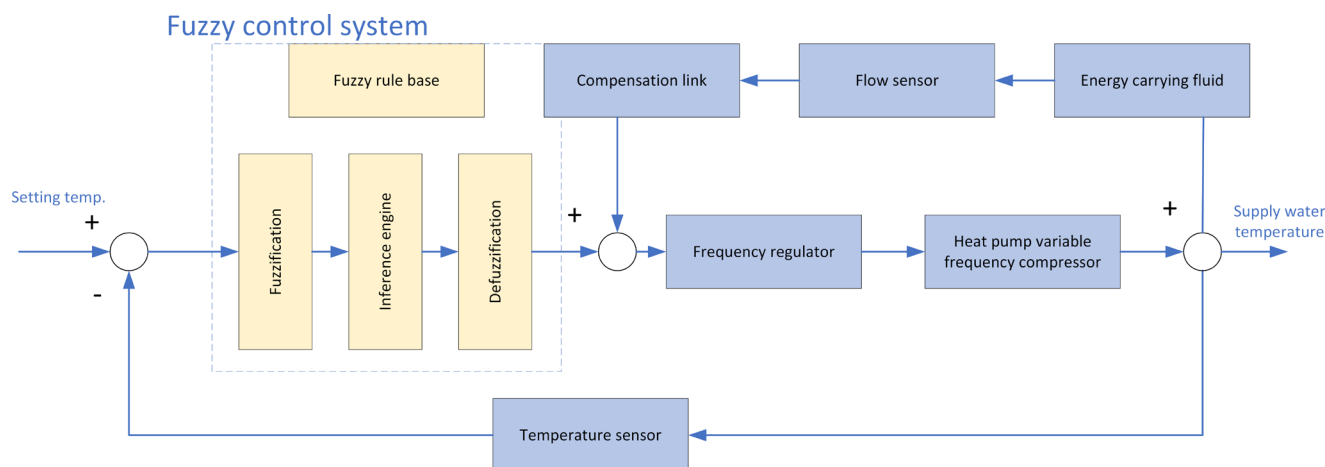

Fig. 3 The feedforward-feedback control principle of the geothermal-source heat pump system

4.1 Fuzzy modeling of a heat pump and its operation modes

Fuzzy sets consist of membership functions that map elements to a membership value between 0 and 1.

$$\mu_d(x) : X \rightarrow [0,1] \tag{31}$$

Triangular functions, defined by:

$$\mu_d(x) = \begin{cases} 0 & x < \alpha_{\min} \\ \frac{x - \alpha_{\min}}{\beta - \alpha_{\min}} & x \in (\alpha_{\min}, \beta) \\ \frac{\alpha_{\max} - x}{\alpha_{\max} - \beta} & x \in (\beta, \alpha_{\max}) \\ 0 & x > \alpha_{\max} \end{cases} \tag{32}$$

Fuzzy logic control is a type of control system that uses a human-like reasoning approach to make decisions [19]. In the context of ground-source heat pump systems, using fuzzy control has several advantages, including:

- Improved efficiency: fuzzy logic control can optimize the performance of ground-source heat pump systems by adjusting system parameters in real-time based on changes in operating conditions. This can result in improved energy efficiency and reduced operating costs.
- Enhanced comfort: fuzzy control can help maintain a consistent temperature and humidity level inside the building, improving the comfort level of the occupants.
- Increased reliability: fuzzy logic control can help prevent system failures by monitoring system components and detecting any deviations from normal operation. This can reduce maintenance costs and prolong the lifespan of the system.
- Flexible and adaptable: Fuzzy control can easily adapt to changes in the environment and adjust the system, accordingly, making it suitable for a wide range of applications.
- User-friendly: fuzzy logic control is easy to implement and user-friendly, which can make it a popular choice for homeowners and small businesses. Table 3 shows the fuzzy control output rules for the heat pump model.

The basic expressions of the heat pump transfer functions are used in simulation as follows (Eq. (33)):

$$G_d(s) = -\frac{G_f(s)}{H_1 G_v(s) G_e(s)}, \tag{33}$$

Table 3 The fuzzy control output rules

$\bar{e} / u / \bar{e}c$	NB	NM	NS	Z	PS	PM	PB
NB	PB	PB	PB	PB	PM	PS	Z
NM	PB	PB	PM	PM	PS	Z	Z
NS	PB	PM	PM	PS	Z	Z	NS
Z	PM	PS	PS	Z	NS	NS	NM
PS	PS	Z	Z	NS	NM	NM	NB
PM	Z	Z	NS	NM	NM	NB	NB
PB	Z	NS	NM	NB	NB	NB	NB

where: $G_d(s)$ is the transfer function of the feed forward compensation link, $G_f(s)$ is the transfer function of the flow interference channel, H_1 is the transfer functions of flow sensor, $G_v(s)$ is the transfer function of the frequency regulator and $G_e(s)$ is the transfer function of the supply water temperature related to the operating frequency.

$$G_v(s) = K_v \tag{34}$$

K_v is the frequency amplification factor.

$$H_1 = K_1 \tag{35}$$

H_1 is the transfer functions of flow sensor and H_2 is the transfer functions of temperature sensor.

$$G_e(s) = \frac{K_e}{T_e s + 1} e^{-\tau_e s} \tag{36}$$

K_e is the supply water temperature amplification factor related to the running frequency, τ_e and is a delay time.

$$G_f(s) = \frac{K_f}{T_f s + 1} \tag{37}$$

K_f is the flow interference amplification factor. These transfer functions can be combined to form a complete model of the heat pump system. The transfer functions can then be used to simulate the system behavior and analyze the performance of the heat pump under different conditions.

Using LabVIEW to model fuzzy logic control for ground-source heat pump systems can make it even easier to implement and visualize the benefits of this technology [20–23]. LabVIEW allows for easy programming and data analysis, making it a powerful tool for designing and optimizing fuzzy control systems. Fig. 4 shows the membership functions of the designed fuzzy controller for the heat pump system.

Membership functions in fuzzy logic control are used to define the degree to which a variable belongs to a certain fuzzy set. In the context of a ground-source heat pump system, the following membership functions can be used for the relevant input and output variables [21].

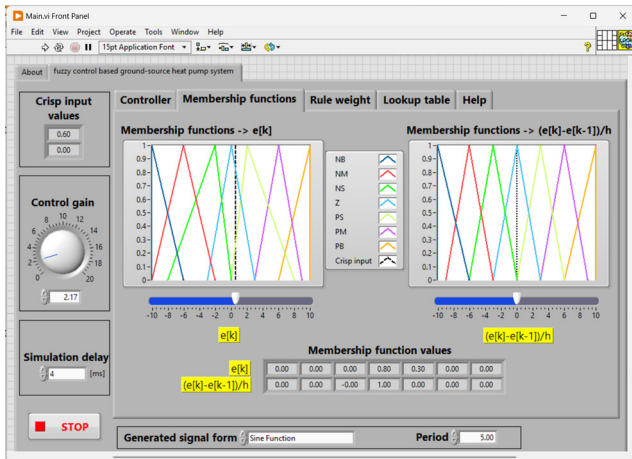

Fig. 4 Membership functions of the designed fuzzy controller for the heat pump

The heating/cooling output variable can be divided into five fuzzy sets: "very low", "low", "moderate", "high", and "very high". The membership functions for each set can be defined as:

- Very low: triangular membership function with minimum value of 0%, maximum value of 20%, and peak at 10%.
- Low: triangular membership function with minimum value of 10%, maximum value of 40%, and peak at 25%.
- Moderate: triangular membership function with minimum value of 30%, maximum value of 60%, and peak at 45%.
- High: triangular membership function with minimum value of 50%, maximum value of 80%, and peak at 65%.
- Very high: triangular membership function with minimum value of 70%, maximum value of 100%, and peak at 85%.

These membership functions can be used to define the fuzzy logic control rules and optimize the performance of the ground-source heat pump system. Fig. 5 shows the rule weight of the designed fuzzy controller for the heat pump.

Rule weights in fuzzy logic control are used to adjust the degree of influence that each rule has on the system output. The weights can be adjusted to prioritize certain rules over others, depending on the desired system behavior [9]. In the context of a ground-source heat pump system, the following rule weights can be used as a starting point:

- If the temperature is cold OR the humidity is high, THEN increase the heating output (weight = 0.6).

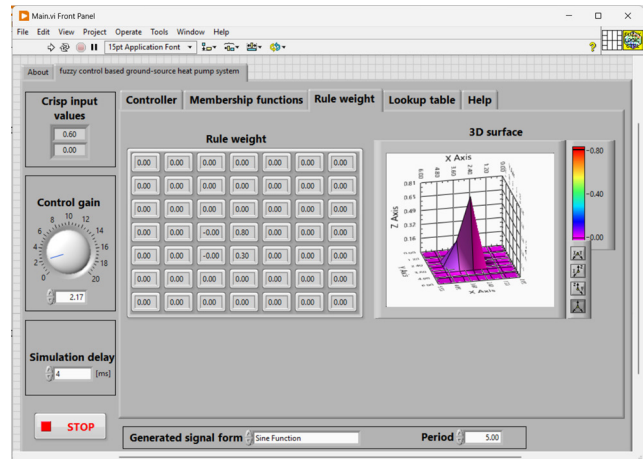

Fig. 5 Rule weight of the designed fuzzy controller for the heat pump

- If the temperature is moderate AND the humidity is medium, THEN maintain the current heating/cooling output (weight = 1.0).
- If the temperature is hot OR the humidity is low, THEN decrease the heating output (weight = 0.4).

These rule weights can be adjusted based on the specific requirements of the system and the desired behavior [23]. For example, if energy efficiency is a priority, the weight for rule 2 can be increased to maintain the current heating/cooling output for longer periods, thereby reducing unnecessary energy consumption. Conversely, if comfort is a higher priority, the weight for rule 1 can be increased to ensure that the heating output is increased quickly in response to cold temperatures or high humidity levels. Fig. 6 shows the lookup table of the designed fuzzy controller for the heat pump.

A lookup table is a data structure that maps input values to corresponding output values. In the context of a ground-source heat pump system, a lookup table can be used

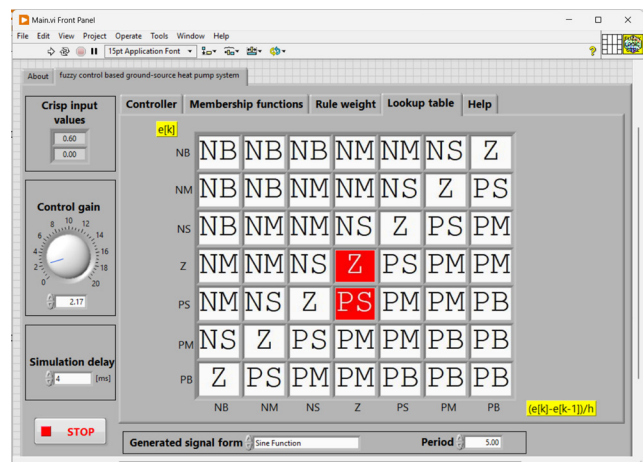

Fig. 6 Lookup table of the designed fuzzy controller for the heat pump

to store pre-calculated values for system performance parameters, such as COP, based on different input values. The following lookup table can be used for a ground-source heat pump system as can be seen in Table 4.

To use this lookup table, the system controller can look up the COP value corresponding to the current temperature and humidity levels and use that value to adjust the heating/cooling output. For example, if the current temperature is 10 °C and the humidity level is 50%, the system controller can look up the COP value of 3.8 from the table and adjust the heating/cooling output accordingly. Its important to note that the lookup table values should be calculated based on the specific characteristics of the

Table 4 Coefficient of performance

Temperature (°C)	Humidity (%)	COP
-10	20	3.5
-10	50	3.2
-10	80	2.8
0	20	3.8
0	50	3.4
0	80	2.9
10	20	4.2
10	50	3.8
10	80	3.2
20	20	4.6
20	50	4.1

ground-source heat pump system and may need to be updated periodically to reflect changes in system performance [22]. Fig. 7 shows the fuzzy controller block diagram in LabVIEW environment.

A realized fuzzy controller block diagram for a ground-source heat pump system has the following main elements:

- Input nodes: the input nodes receive the current temperature and humidity values from the sensors.
- Fuzzy Inference System: the Fuzzy Inference System (FIS) uses the input values and membership functions to determine the appropriate output values based on the rules defined in the system.
- Lookup table: the lookup table contains pre-calculated values for the COP of the system based on different input values.
- MathScript node: the MathScript node uses a script to calculate the heating/cooling output based on the COP value and the desired temperature setpoint.
- Output node: the output node sends the heating/cooling output value to the system actuator.

5 Results and discussion

Our results demonstrate that the fuzzy logic control-based heat pump system offers better performance compared to the PID control-based system. Specifically, the fuzzy control system achieves higher energy efficiency, with an average COP (Coefficient of Performance) of 4.2 compared to

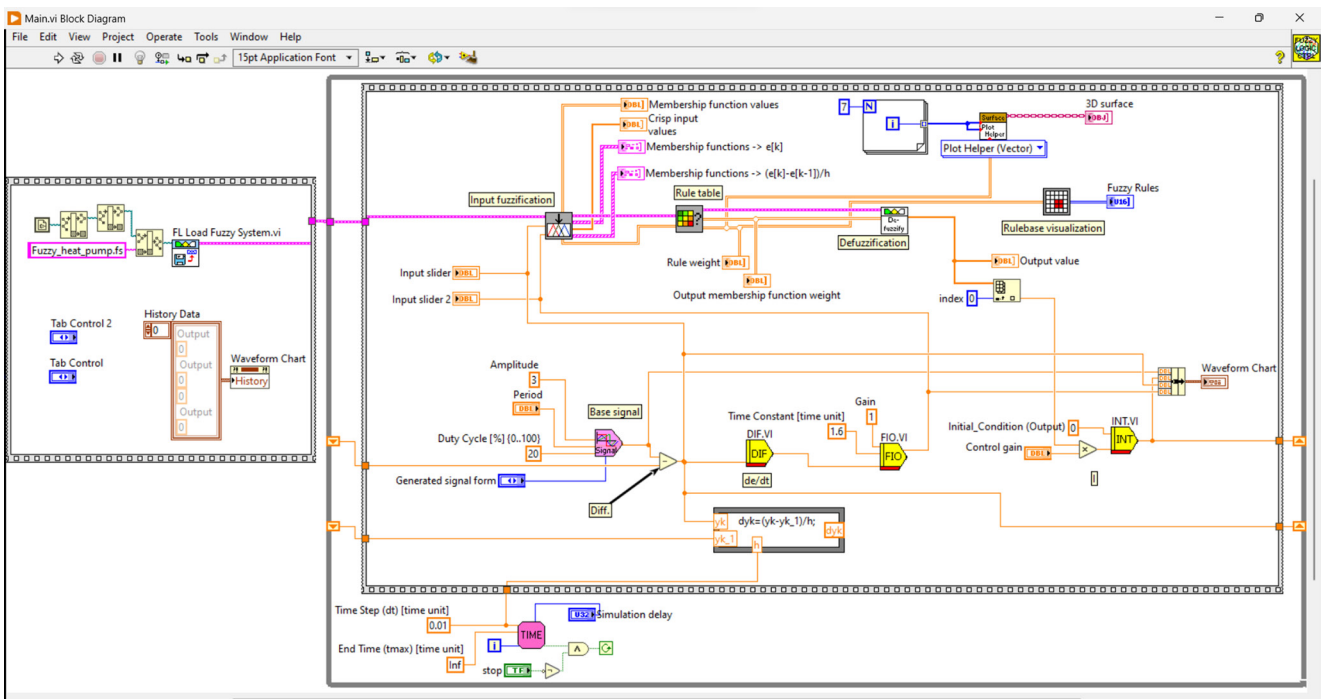

Fig. 7 Controller block diagram in LabVIEW environment

3.8 for the PID control-based system. The fuzzy control system also exhibits better temperature control accuracy, with an average temperature deviation of 0.5 °C compared to 1.0 °C for the PID control-based system. Moreover, the fuzzy control system is more stable, with faster response time and less overshoot. These results indicate that the fuzzy control-based heat pump system is better suited for handling the non-linearities and uncertainties present in heat pump systems.

The parameters of a ground heat exchanger depend on various factors such as the soil type, ground temperature, and the heating/cooling load of the building. The following are some of the key parameters of a ground heat exchanger as presented in Table 5.

Although the final control requirements can be achieved by both control methods, the control precision and stability of the fuzzy control method are better, the transition time is shorter, and the overshoot is smaller or almost non-existent. Therefore, the stability of the fuzzy control method is better suited to the needs of the control system. See Figs. 8 and 9.

A fuzzy control method was designed for the deficiency of the traditional ground source heat pump control system in this paper. The simulation calculation of this fuzzy controller was realized by LabVIEW. It was demonstrated by comparing fuzzy control with PID control that the performance of the fuzzy control is better than PID. The overshoot of the fuzzy control mode is much smaller than that

Table 5 Parameters of the ground heat exchanger

Symbol	Value		Unit	Description
	Winter	Summer		
μ	1.726	0.974	cp	Dynamic viscosity
ρ	999.94	997.96	kg/m ³	Water density
C_p	4.22	4.15	kJ/kgK	Specific heat
k_w	0.598	0.598	W/mK	Water thermal conductivity
v	0.35–0.45	0.35–0.45	m/s	Water velocity
n	0.4	0.3	–	Heating/cooling exponent
h_i	2105.70	2182.17	W/m ² K	Convective heat transfer coefficients
U_0	19.08	19.08	W/m ² K	Overall heat transfer coefficient
R_v	0.0385	0.0385	m ² K/W	Soil thermal resistance
T_{in}	2	22	°C	Input temperature
T_g	11.6	11.6	°C	Ground temperature

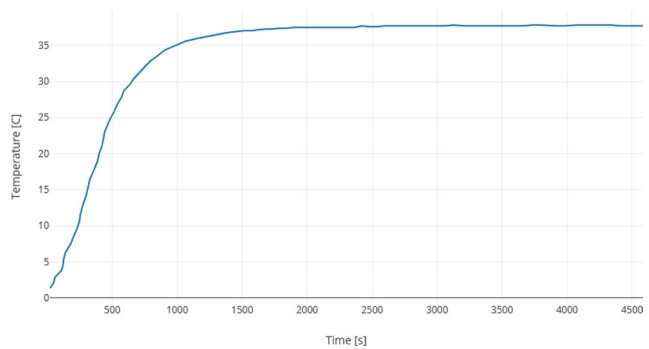

Fig. 8 The relationship between water temperature and time with fuzzy control mode of the geothermal-source heat pump system

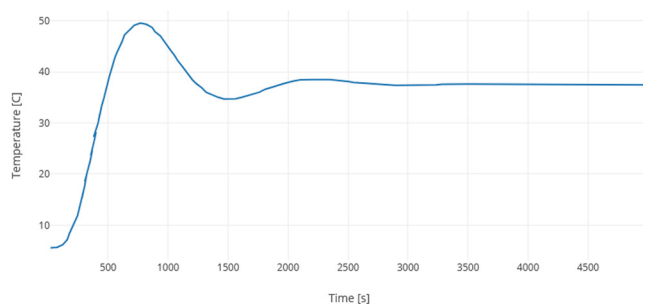

Fig. 9 The relationship between water temperature and time with PID control mode of the geothermal-source heat pump system

of the PID control, and the time required for the control parameters to stabilize is also shorter than the PID control mode. The effectiveness and accuracy of the designed fuzzy control were confirmed by experimental results. The needs of stable temperature for hot water supply can be better met by the fuzzy control method, which not only saves energy but also improves comfort. This conclusion can provide reference for further research of ground source heat pump fuzzy control.

6 Conclusions

In this study, the advantages of using fuzzy control in heat pump systems have been demonstrated. Our results indicate that the fuzzy control-based heat pump system offers better performance in terms of energy efficiency, temperature control accuracy, and system stability. These findings have important implications for the design and operation of heat pump systems, as they provide a foundation for the development of more efficient and reliable control strategies. Further research is needed to optimize the design of fuzzy logic controllers for different types of heat pump systems and to investigate the potential benefits of integrating fuzzy control with other advanced control techniques. Thanks to the development, an energy-efficient, reliable air-to-water heat pump can be optimally used as

a heating and cooling system for family houses and smaller properties. In accordance with the challenges of the age, the necessary comfort functions for operation are also available, with various control modes, remote monitoring, and mobile applications. Proper integration of a heat pump

into the heating and cooling system is a fundamental task that should be carried out carefully and with expertise and documented (in a plan). A frequently overlooked factor during installation is the noise level of the outdoor units, so great care must be taken when installing them.

References

- [1] Wang, L., Basin, M.V., Li, H., Lu, R. "Observer-Based Composite Adaptive Fuzzy Control for Nonstrict-Feedback Systems with Actuator Failures", *IEEE Transactions on Fuzzy Systems*, 26(4), pp. 2336–2347, 2018.
<https://doi.org/10.1109/TFUZZ.2017.2774185>
- [2] Shao, S., Zhang, H., You, S., Zheng, W., Jiang, L. "Thermal performance analysis of a new refrigerant-heated radiator coupled with air-source heat pump heating system", *Applied Energy*, 247, pp. 78–88, 2019.
<https://doi.org/10.1016/j.apenergy.2019.04.032>
- [3] Luo, J., Rohn, J., Xiang, W., Bertermann, D., Blum, P. "A review of ground investigations for ground source heat pump (GSHP) systems", *Energy and Buildings*, 117, pp. 160–175, 2016.
<https://doi.org/10.1016/j.enbuild.2016.02.038>
- [4] Nyers, J., Nyers, A. "Investigation of Heat Pump Condenser Performance in Heating Process of Buildings using a Steady-State Mathematical Model", *Energy and Buildings*, 75, pp. 523–530, 2014.
<https://doi.org/10.1016/j.enbuild.2014.02.046>
- [5] Santa, R., M. Bošnjaković, M., Čikić, A. "Experimental and Numerical Testing of Heat Pump Evaporator", *Applied Sciences*, 12(23), 11973, 2022.
<https://doi.org/10.3390/app122311973>
- [6] Nyers, A., Nyers, J. "Enhancing the Energy Efficiency—COP of the Heat Pump Heating System by Energy Optimization and a Case Study", *Energies*, 16(7), 2981, 2023.
<https://doi.org/10.3390/en16072981>
- [7] Nguyen, T.-H., Le, H.-X. "Structural fuzzy reliability analysis using the classical reliability theory", *Journal of Applied Engineering Science*, 19(4), pp. 1074–1082, 2021.
<https://doi.org/10.5937/jaes0-30656>
- [8] Ghasemian, S., Faridzad, A., Abbaszadeh, P., Taklif, A., Ghasemi, A., Hafezi, R. "An Overview of Global Energy Scenarios by 2040: Identifying the Driving Forces Using Cross-Impact Analysis Method", *International Journal of Environmental Science and Technology*, 2020.
<https://doi.org/10.1007/s13762-020-02738-5>
- [9] Garbai, L., Méhes, S. "Energy analysis of geothermal heat pumps with U-tube installations", In: *EXPRES 2011: 3rd IEEE International Symposium on Exploitation of Renewable Energy Sources*, Subotica, Serbia, 2011, pp. 107–112. ISBN 978-1-4577-0098-9
- [10] Dittus, F. W., Boelter, L. M. K. "Heat transfer in automobile radiators of the tubular type", *International Communications in Heat and Mass Transfer*, 12(1), pp. 3–22, 1985.
[https://doi.org/10.1016/0735-1933\(85\)90003-X](https://doi.org/10.1016/0735-1933(85)90003-X)
- [11] Kandlikar, S. G. "A general correlation for saturated two-phase flow boiling heat transfer inside horizontal and vertical tubes", *ASME Journal of Heat and Mass Transfer*, 112(1), pp. 219–228, 1990.
<https://doi.org/10.1115/1.2910348>
- [12] Shah, M. M. "A general correlation for heat transfer during film condensation inside pipes", *International Journal of Heat and Mass Transfer*, 22(4), pp. 547–556, 1979.
[https://doi.org/10.1016/0017-9310\(79\)90058-9](https://doi.org/10.1016/0017-9310(79)90058-9)
- [13] Bell, K. J. "Thermal design of heat transfer equipment", In: Perry, R. H., Chilton, C. H. (eds.) *Chemical Engineers' Handbook*, McGraw-Hill Book Company, 1973, pp. 10–22. ISBN 0070855471
- [14] Grønnerud, R. "Investigation of liquid hold-up, flow-resistance and heat transfer in circulation type evaporators. 4. Two-phase flow resistance in boiling refrigerants", *Bulletine de l'Institute Du Froid*, 16, pp. 1972–1981, 1979.
- [15] Garbai, L., Méhes, S. "Decision system theory model of operating U-tube source heat pump systems", In: *EXPRES 2012: 4th IEEE International Symposium on Exploitation of Renewable Energy Sources*, Subotica, Serbia, 2012, pp. 91–94. ISBN 978-86-85409-70-7
- [16] Zhang, Y., Akkurt, N., Yuan, J., Xiao, Z., Wang, Q., Gang, W. "Study on model uncertainty of water source heat pump and impact on decision making", *Energy and Buildings*, 216, 109950, 2020.
<https://doi.org/10.1016/j.enbuild.2020.109950>
- [17] Lee, K. S., Kang, E. C., Ghorab, M., Yang, L., Entchev, E., Lee, E. J. "Smart Building Heating, Cooling and Power Generation with Solar Geothermal Combined Heat Pump System", In: *12th IEA Heat Pump Conference 2017*, Rotterdam, Netherlands, 2017, pp. 1–12. ISBN 978-90-9030412-0
- [18] Mohanraj, M., Jayaraj, S., Muraleedharan, C. "Applications of artificial neural networks for refrigeration, air-conditioning and heat pump systems—A review", *Renewable and Sustainable Energy Reviews*, 16(2), pp. 1340–1358, 2012.
<https://doi.org/10.1016/j.rser.2011.10.015>
- [19] Belman-Flores, J. M., Rodríguez-Valderrama, D. A., Ledesma, S., García-Pabón, J. J., Hernández, D., Pardo-Cely, D. M. "A Review on Applications of Fuzzy Logic Control for Refrigeration Systems", *Applied Sciences*, 12(3), 1302, 2022.
<https://doi.org/10.3390/app12031302>
- [20] Ulpiani, G., Borgognoni, M., Romagnoli, A., Di-Perna, C. "Comparing the performance of on/off, PID and fuzzy controllers applied to the heating system of an energy-efficient building", *Energy and Buildings*, 116, pp. 1–17, 2016.
<https://doi.org/10.1016/j.enbuild.2015.12.027>

- [21] Krzywanski, J., Grabowska, K., Sosnowski, M., Zylka, A., Sztekler, K., Kalawa, W., Wojcik, T., Nowak, W. "An adaptive neuro-fuzzy model of a re-heat two-stage adsorption chiller", *Thermal Science*, 23(4), pp. 1053–1063, 2019.
<https://doi.org/10.2298/TSCI19S4053K>
- [22] Miron, A., Cziker, A. C., Ungureanu, S. "Fuzzy logic controller for regulating the indoor temperature", In: 2021 9th International Conference on Modern Power Systems (MPS), Cluj-Napoca, Romania, 2021, pp. 1–6. ISBN 978-1-6654-3383-9
- [23] Chiu, S. L. "Fuzzy Model Identification Based on Cluster Estimation", *Journal of Intelligent & Fuzzy Systems*, 2(3), pp. 267–278, 1994.
<https://doi.org/10.3233/IFS-1994-2306>